

Lampes-à-porter 2024

CATALOGO / CATALOG



zafferano

Lampes-à-porter 2024

Zafferano Lampes-à-porter: un nuovo modo di vivere la luce.

Superando la tradizione e i vincoli di disponibilità di corrente elettrica, le lampade senza fili Zafferano si muovono con te, portando la luce ovunque serva: per creare la giusta atmosfera al tavolo di un ristorante, illuminare una cena in terrazza, permettere la lettura sotto le stelle... e non temono la pioggia!

Forme pulite e un'ampia gamma di colori rendono queste lampade adatte a qualsiasi situazione; intensità e temperatura di colore si regolano in modo intuitivo; infine, la batteria si ricarica comodamente su basi a contatto.

In ogni spazio pubblico e privato, una lampada senza fili Zafferano soddisfa l'esigenza moderna di illuminare ambienti in cui la distinzione tra interno ed esterno è fluida; è un'ottima idea regalo; e la soluzione ideale in luoghi privi di corrente elettrica.

Sono lampade destinate a durare: sia le schede LED sia le batterie (esaurito il loro ciclo di vita di circa 450 ricariche) possono essere sostituite facilmente, regalando nuova vita alla lampada.

Con una lampada portatile Zafferano avrai la luce che desideri e gli standard più avanzati di design, qualità e tecnologia, sempre a portata di mano. Anzi, no: con la tecnologia Wi-Fi incorporata, potrai controllarle anche da remoto...

Zafferano Lampes-à-porter: a new way to experience light.

Overcoming tradition and the constraints of electricity availability, Zafferano cordless lamps move with you, bringing light wherever you need it: to create the right atmosphere at a restaurant table, to illuminate a dinner on a terrace, to allow reading under the stars... and they are not afraid of the rain!

Clean shapes and a wide range of colors make these lamps suitable for any situation; intensity and color temperature are intuitively adjusted; and finally, the battery is conveniently recharged on contact bases.





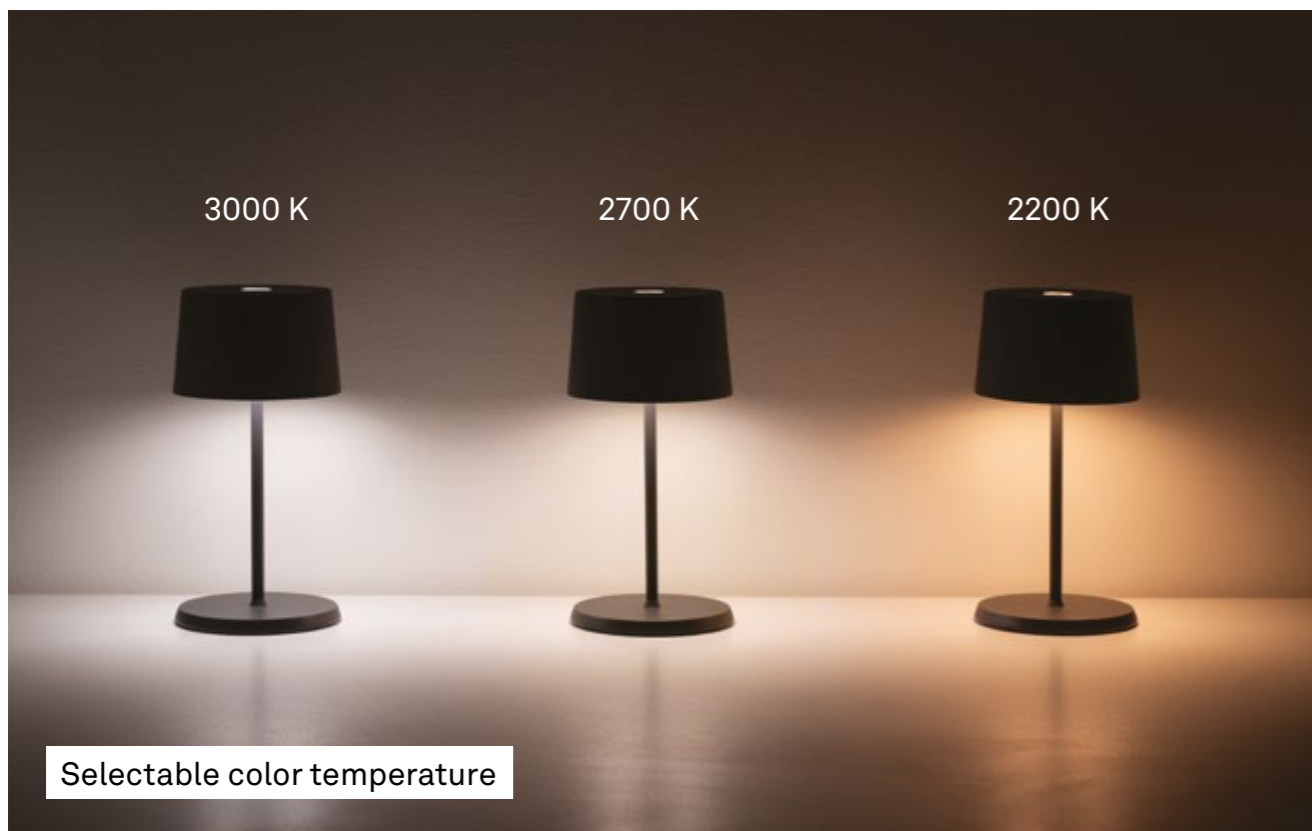









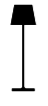





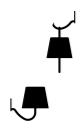











In any public or private space, a Zafferano cordless lamp meets the modern need to illuminate environments where boundaries between indoors and outdoors are blurred; it is a great gift idea and the ideal solution in places without electricity.















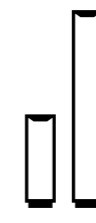

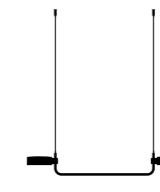

Finally, these lamps are made to last: both the LED boards and the batteries (when worn: after about 450 recharges) can be easily replaced, giving the lamp a new life. With a Zafferano portable lamp, you get exactly the light you want and the most advanced standards of design, quality and technology at your fingertips. Even better: with built-in Wi-Fi technology, you can even control them remotely...



Indice

Index

							
	08	18	20	22	24		
	Sister Light Wi-Fi	Tavolo Table	Mini tavolo Mini table	Picchetto Lamp with peg	Parete Wall		
							
26	36	42	46	50	52	54	56
Poldina	Tavolo Table	Mini tavolo Mini table	Micro tavolo Micro table	L desk tavolo L desk table	L terra-tavolo L floor-table	XXL terra- tavolo XXL floor-table	Picchetto Lamp with peg
							
58	60	62	66	70	72	76	78
Sospensione Suspension	Parete Wall	Cover	Poldina Reverso	Tavolo Table	Poldina Stopper	Stopper	Bottiglia Lido Lido Bottle
							
80	86	88	90	92	94	96	100
Amelie	Tavolo Table	Terra Floor	Picchetto Lamp with peg	Sospensione Suspension	Parete Wall	Circe	Tavolo Table
							
102	108	110	114	116	122	124	128
Pina	Tavolo Table	Supporto terra Floor stand	Vassoio Tray	Swap	Tavolo Table	Mini tavolo Mini table	Paralumi Lampshades
							
134	138	140	142	146	148	150	
Ofelia	Tavolo Table	Micro tavolo Micro table	Olivia	Tavolo Table	Mini tavolo Mini table	Micro tavolo Micro table	

							
152	154	156	160	162	164		
Push-up	Tavolo Table	Olimpia	Tavolo Table	Dama	Tavolo Table		
							
166	168	170	172	174	176		
Home	Tavolo Table	Supporto parete Wall lamp kit	Home Solar	Paletto Bollard	Base zavorra Stabilizing base		
							
178	186	188	190	192	194	196	
Super O	Tavolo Table	Terra Floor	Terra sospesa Ceiling-suspended floor	Sospensione Suspension	Parete Wall	Parete Wall	
							
198	202	204	205	206	207	208	209
Pencil	Modulo luminoso con accessori Lighting module with accessories						
							
210	214	216	222		10		
Liola	Piano d'appoggio multiuso Multipurpose three-legged	Accessori e ricambi Accessories and spare parts	Personalizzazione Customization		Zafferano Lighting		



Indice per codice lampade

Index by code (lamps)

CODE	PAGE	CODE	PAGE	CODE	PAGE	CODE	PAGE	CODE	PAGE	CODE	PAGE
LD0256G3	175	LD0340X3		LD0610N3		LD1005O3		LD1083V3		LD1158N3	
LD0256R3		LD0349A3	77	LD0682B3	57	LD1005R3		LD1090B3	87	LD1159B3	
LD0257G3		LD0349B3		LD0682N3		LD1011B3	125	LD1090D3		LD1159N3	
LD0257R3		LD0349D3		LD0682R3		LD1011K3		LD1090T3		LD1650B3	109
LD0258B3	169	LD0349F3		LD0686B3	59	LD1011L3		LD1090V3		LD1650BFA	
LD0258N3		LD0349G3		LD0686N3		LD1011V3		LD1091B3	93	LD1650BFO	
LD0258R3		LD0349S3		LD0686R3		LD1011Z3		LD1091D3		LD1650D3	
LD0320B3	44	LD0360B3	55	LD0688B3	61	LD1030B3	123	LD1091T3		LD1650DFO	
LD0320BFA	45	LD0360N3		LD0688N3		LD1030N3		LD1091V3		LD1650N3	
LD0320BFO		LD0360R3		LD0688R3		LD1030R3		LD1092B3	95	LD1650R3	
LD0320C3		LD0390B3	53	LD0689B3	61	LD1050B3	155	LD1092D3		LD1650RFR	
LD0320N3	44	LD0390N3		LD0689N3		LD1050N3		LD1092T3		LD1650S3	
LD0320O3	45	LD0390R3		LD0689R3		LD1050R3		LD1092V3		LD1840B3	151
LD0320R3	44	LD0395B3	51	LD0800B3	203	LD1050S3		LD1094B3	91	LD1840N3	
LD0320RFR	45	LD0395N3		LD0800G3		LD1031O3	127	LD1094D3		LD1840R3	
LD0320S3	44	LD0395R3		LD0800R3		LD1031R3		LD1094T3		LD1840S3	
LD0340A3	38	LD0420B3	71	LD0801B3		LD1080B3	19	LD1094V3		LD1850R3	147
LD0340AFO	39	LD0420G3		LD0801G3		LD1080D3		LD1096B3	89	LD1850S3	
LD0340B3	37	LD0420N3		LD0801R3		LD1080I3		LD1096D3		LD1860B3	148
LD0340BFA	39	LD0420R3		LD0802B3		LD1080O3		LD1096T3		LD1860N3	
LD0340BFO		LD0420S3		LD0802G3		LD1080R3		LD1096V3		LD1860R3	
LD0340BP2	41	LD0490B3	48	LD0802R3		LD1080V3		LD1131N3	127	LD1870B3	139
LD0340BP3		LD0490C3	49	LD0850B3	147	LD1081B3	21	LD1150B3	197	LD1870G3	
LD0340BP4		LD0490D3	48	LD0850BFA		LD1081D3		LD1150N3		LD1870N3	
LD0340C3	38	LD0490DFO	49	LD0850BFO		LD1081I3		LD1151B3	195	LD1870R3	
LD0340D3	37	LD0490F3	48	LD0850N3		LD1081O3		LD1151N3		LD1870S3	
LD0340DFO	39	LD0490FFO	49	LD0850RFR		LD1081R3		LD1152B3	187	LD1880B3	141
LD0340F3	38	LD0490G3	48	LD0860K3	149	LD1081V3		LD1152N3		LD1880G3	
LD0340FFO	39	LD0490K3		LD0860L3		LD1082B3	25	LD1153B3	193	LD1880N3	
LD0340FP1	41	LD0490KFO	49	LD0860V3		LD1082D3		LD1153N3		LD1880R3	
LD0340G3	38	LD0490L3	48	LD0860Z3		LD1082I3		LD1154B3	189	LD1880S3	
LD0340M3	37	LD0490N3		LD0900B3	161	LD1082O3		LD1154N3		LD2130O3	123
LD0340N3		LD0490O3	49	LD0900C3		LD1082R3		LD1155B3		LD2130T3	
LD0340O3	38	LD0490P3	48	LD0900E3		LD1082V3		LD1155N3		LD2130W3	
LD0340P3		LD0490R3		LD0900N3		LD1083B3	23	LD1156B3		LD2131O3	127
LD0340R3	37	LD0490S3		LD0900O3		LD1083D3		LD1156N3		LD2131T3	
LD0340RFR	39	LD0490V3		LD1005B3	101	LD1083I3		LD1157B3	191	LD2131W3	
LD0340RP5	41	LD0490Z3		LD1005E3		LD1083O3		LD1157N3			
LD0340S3	37	LD0610B3	165	LD1005N3		LD1083R3		LD1158B3			

Sister Light Wi-Fi ^{PRO}

Design Federico de Majo

Sister Light Wi-Fi è una collezione di lampade a batteria, portatili e ricaricabili, controllabili anche da remoto mediante l'utilizzo dell'applicazione Zafferano Lighting (pag. 10).

La collezione comprende i modelli da tavolo (in due varianti), da parete e con picchetto. Nella parte superiore della testa è presente un controllo "touch", che permette l'accensione, la dimmerazione a 4 step e la selezione della temperatura di colore della luce. Grazie all'indice di protezione IP65, sono utilizzabili anche all'esterno; sono inoltre resistenti alla nebbia salina (1500 h). Possiedono un sistema di controllo elettronico che monitora l'autonomia residua e garantisce un flusso luminoso costante fino all'esaurimento della batteria, permettendo di ottimizzare le ricariche ed effettuarle sempre in maniera corretta. Tutti i modelli si ricaricano svitando la testa e ponendola sulla base di ricarica a contatto, inclusa; i modelli da tavolo si ricaricano anche appoggiando la lampada sulla base di ricarica a contatto. Caricabatterie non incluso.

Sister Light Wi-Fi is a collection of portable, rechargeable battery-operated lamps that can be remote controlled using the Zafferano Lighting app (pg. 10).

The collection includes the following models: table lamp (two heights), wall lamp and lamp with peg. On the head, a touch control allows you to turn it on/off, dim (4-step: 100%, 60%, 30%, 6%) and select the color temperature of the light. With their IP65 rating, the lamps can also be used outdoors; they are salt spray resistant (1500 h). All models feature an electronic control system that monitors the remaining autonomy and ensures a constant luminous flux until the battery runs out. Recharging is therefore optimized and always properly done. All models can be recharged by unscrewing the top and positioning it on the contact charging base, included. The table versions can be recharged also by positioning the whole lamp on the contact charging base. Battery charger not included.



LINK TO VIDEO

TAVOLO / MINI TAVOLO / PICCHETTO / PARETE
TABLE / MINI TABLE / LAMP WITH PEG / WALL



Sister Light Wi-Fi table lamp ivory → **LD108013**
Lido ceramic bottle sand bands → **FAS1507**
Gessato tumbler clear → **GS00101**



Zafferano Lighting

App



Con l'integrazione della tecnologia Wi-Fi, le nostre lampade ricaricabili entrano in una nuova dimensione: oltre al controllo di accensione, spegnimento e settaggio da remoto, esse acquisiscono funzionalità aggiuntive come la possibilità di raggrupparle per controllo in contemporanea, la disabilitazione del tasto touch fisico, la verifica del livello della batteria, il controllo puntuale del livello di intensità e della temperatura di colore della luce (bianco dinamico). Nuove funzionalità e migliorie si aggiungono in automatico ad ogni aggiornamento del software.

With the integration of Wi-Fi technology, our cordless lamps enter a new dimension: beyond remote control of turning on/off and setting, they gain additional functions such as the ability to group them for all-at-once control, to disable the touch button, to monitor the battery charge level, to set the intensity and color temperature of the light in more accurate ways (e.g. tunable dynamic white). New features and enhancements are automatically added with each update of the dedicated software.

L'applicazione Zafferano Lighting permette di controllare da remoto la tua lampada e di:

- Creare e controllare gruppi di lampade
- Dimmer 1-100 con step personalizzati
- Bianco dinamico (2200K-4000K) con possibilità di creare step personalizzati
- Disabilitazione del "touch" di controllo
- Controllo del livello di carica della batteria
- Impostare timer spegnimento lampada
- Impostare luce notturna di cortesia
- Impostare Eco-Mode
- Disabilitare il LED di stato
- Definire tempo di connessione al Wi-Fi
- Attivare modalità emergenza

The Zafferano Lighting app allows you to remotely control your lamp and to:

- Grouping lamps for all-at-once control
- Dimming 1-100 and preset custom dim levels
- Tunable Dynamic White (2200K-4000K) and preset custom color temperature levels
- Disabling touch control
- Monitoring battery charge level
- Time programming (lamp off)
- Activating night light
- Activating Eco Mode
- Disabling status LED
- Wi-Fi connection time-setting
- Activating Emergency Mode

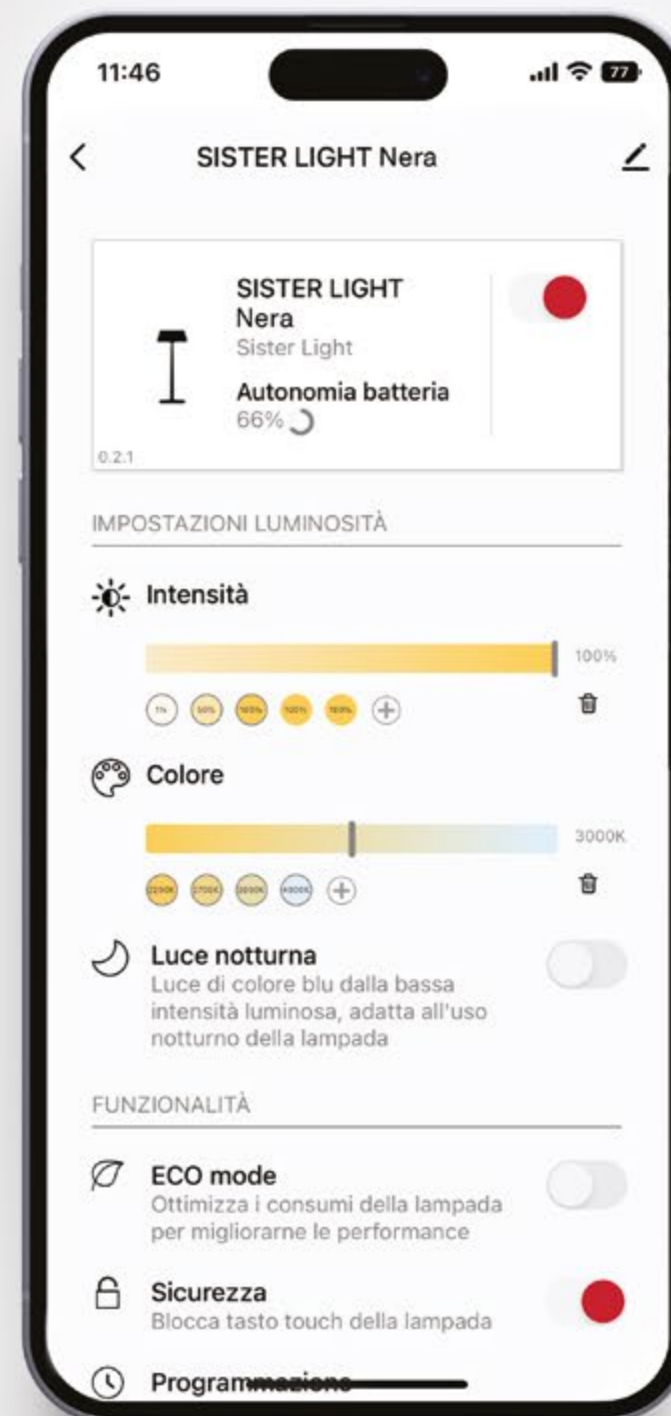

DOWNLOAD

Sister Light Wi-Fi table lamp
copper → **LD1080R3**
42 Restaurant & Bar
Esztergom, Hungary
Photo Patrik Fábian

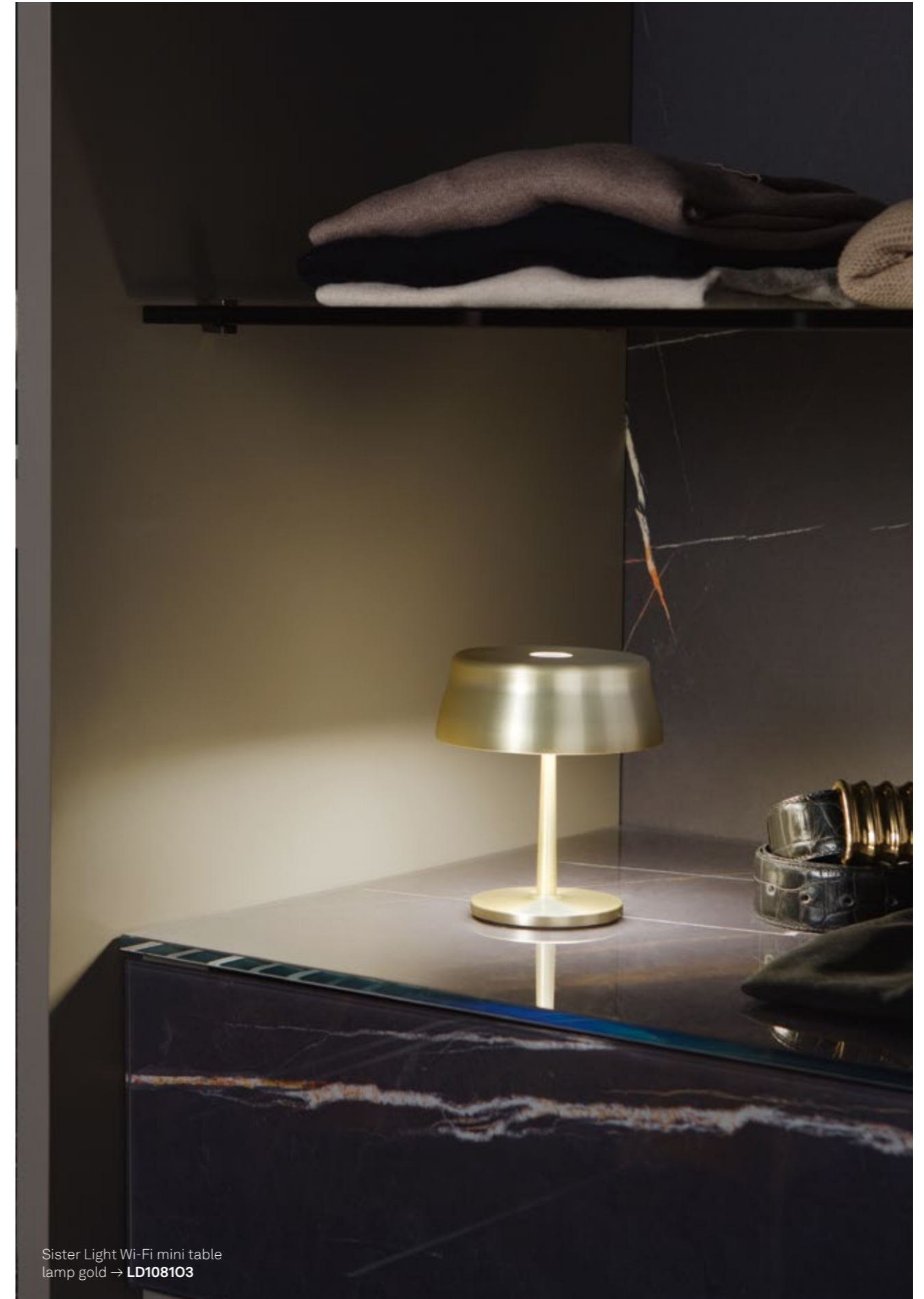

Sister Light Wi-Fi mini table
lamp gold → **LD108103**

Sister Light Wi-Fi lamp with peg
pearly white → **LD1083B3**



Sister Light Wi-Fi wall lamp
copper → **LD1082R3**





Sister Light Wi-Fi table lamp
black → **LD1080D3**

Sister Light Wi-Fi^{PRO}

Tavolo Table

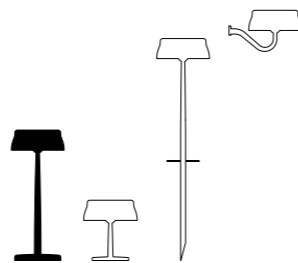

Dati tecnici

Technical data

LED TOUCH DIMMER

2200-2700-3000-4000 K | CRI>90
250-275-296-338 lm | 3,2 W | IP65
5 V max 2A



Corpo in alluminio anodizzato spazzolato (oro, rame, verde) oppure verniciato (bianco perlato, nero perlato, avorio)
Brushed anodized (gold, copper, green) or painted aluminum body (pearly white, pearly black, ivory)

Diffusore in policarbonato prismatico
Prismatic polycarbonate diffuser

Adatta all'uso esterno (lampada IP65) e interno (lampada su base di ricarica IP20)
Suitable for outdoor (lamp IP65) and indoor use (lamp on charging base IP20)

Resistenza agli urti (IK07) e alla nebbia salina (1500h)
Impact resistance (IK07) and salt spray resistance (1500h)

Durata 8 - 36 h, in base alla regolazione del flusso luminoso e alle impostazioni del Wi-Fi
Battery lasts 8 - 36 h, depending on the luminous flux and Wi-Fi setting

Tempo di ricarica a 2A: 5 h
Charging time at 2A: 5 h

Pacco batteria al litio ricaricabile e sostituibile
Rechargeable and replaceable lithium battery pack

Firmware del dispositivo aggiornabile da remoto
Remotely upgradable device firmware

Avvertenze

Remarks

Per poter funzionare, la lampada deve essere collegata a una rete Wi-Fi con frequenza 2,4 GHz.
In order to work, the lamp must be connected to a 2.4 GHz frequency Wi-Fi network.

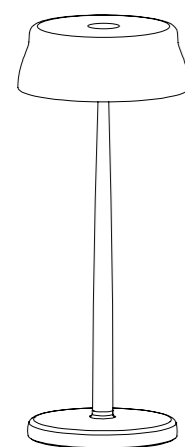

Ø 13,2 x 33 cm
Ø 5,2 x 13 in

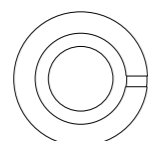

Ø 11,3 cm
Ø 4,4 in

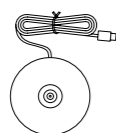

Ø 7,5 cm
Ø 2,9"

Componenti inclusi Components included

Base di ricarica a contatto
Contact charging base

Adattatore per base di ricarica a contatto
Contact charging base adapter

Accessori non inclusi Accessories not included

Caricatore / Charger → **LD0300UC** (pg. 217)
5 V max 2,1 A | 100-240V | USB-A

Finiture Finishes



LD108003
Oro / Gold



LD1080R3
Rame / Copper



LD1080V3
Verde / Green



LD1080B3
Bianco perlato / Pearly white
RAL 9010



LD1080D3
Nero perlato / Pearly black
RAL 9011



LD1080I3
Avorio / Ivory
RAL 1015

Sister Light Wi-Fi^{PRO}

Mini tavolo Mini table

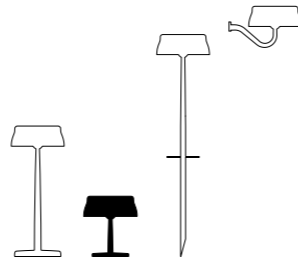

Dati tecnici

Technical data

LED TOUCH DIMMER

2200-2700-3000-4000 K | CRI>90
250-275-296-338 lm | 3,2 W | IP65
5 V max 2A



Corpo in alluminio anodizzato spazzolato (oro, rame, verde) oppure verniciato (bianco perlato, nero perlato, avorio)
Brushed anodized (gold, copper, green) or painted aluminum body (pearly white, pearly black, ivory)

Diffusore in policarbonato prismatico
Prismatic polycarbonate diffuser

Adatta all'uso esterno (lampada IP65) e interno (lampada su base di ricarica IP20)
Suitable for outdoor (lamp IP65) and indoor use (lamp on charging base IP20)

Resistenza agli urti (IK07) e alla nebbia salina (1500h)
Impact resistance (IK07) and salt spray resistance (1500h)

Durata 8 - 36 h, in base alla regolazione del flusso luminoso e alle impostazioni del Wi-Fi
Battery lasts 8 - 36 h, depending on the luminous flux and Wi-Fi setting

Tempo di ricarica a 2A: 5 h
Charging time at 2A: 5 h

Pacco batteria al litio ricaricabile e sostituibile
Rechargeable and replaceable lithium battery pack

Firmware del dispositivo aggiornabile da remoto
Remotely upgradable device firmware

Avvertenze

Remarks

Per poter funzionare, la lampada deve essere collegata a una rete Wi-Fi con frequenza 2,4 GHz.
In order to work, the lamp must be connected to a 2.4 GHz frequency Wi-Fi network.

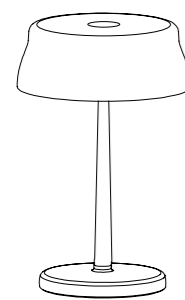

Ø 13,2 x 17 cm
Ø 5,2 x 6,7 in

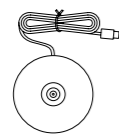

Ø 7,5 cm
Ø 2,9"

Componenti inclusi

Components included

Base di ricarica a contatto
Contact charging base

Adattatore per base di ricarica a contatto
Contact charging base adapter

Accessori non inclusi

Accessories not included

Caricatore / Charger → **LD0300UC** (pg. 217)
5 V max 2,1 A | 100-240V | USB-A

Finiture

Finishes



LD108103

Oro / Gold



LD1081R3

Rame / Copper



LD1081V3

Verde / Green



LD1081B3

Bianco perlato / Pearly white
RAL 9010



LD1081D3

Nero perlato / Pearly black
RAL 9011



LD1081I3

Avorio / Ivory
RAL 1015

Sister Light Wi-Fi^{PRO}

Picchetto Lamp with peg

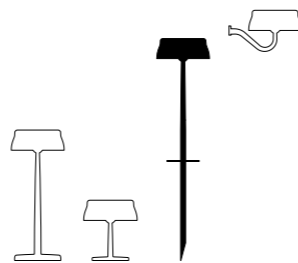

Dati tecnici

Technical data

LED TOUCH DIMMER

2200-2700-3000-4000 K | CRI>90
250-275-296-338 lm | 3,2 W | IP65
5 V max 2A



Corpo in alluminio anodizzato spazzolato (oro, rame, verde) oppure verniciato (bianco perlato, nero perlato, avorio)
Brushed anodized (gold, copper, green) or painted aluminum body (pearly white, pearly black, ivory)

Diffusore in policarbonato prismatico
Prismatic polycarbonate diffuser

Adatta all'uso esterno (lampada IP65) e interno (lampada su base di ricarica IP20)
Suitable for outdoor (lamp IP65) and indoor use (lamp on charging base IP20)

Resistenza agli urti (IK07) e alla nebbia salina (1500h)
Impact resistance (IK07) and salt spray resistance (1500h)

Durata 8 - 36 h, in base alla regolazione del flusso luminoso e alle impostazioni del Wi-Fi
Battery lasts 8 - 36 h, depending on the luminous flux and Wi-Fi setting

Tempo di ricarica a 2A: 5 h
Charging time at 2A: 5 h

Pacco batteria al litio ricaricabile e sostituibile
Rechargeable and replaceable lithium battery pack

Firmware del dispositivo aggiornabile da remoto
Remotely upgradable device firmware

Avvertenze

Remarks

Per poter funzionare, la lampada deve essere collegata a una rete Wi-Fi con frequenza 2,4 GHz.
In order to work, the lamp must be connected to a 2.4 GHz frequency Wi-Fi network.

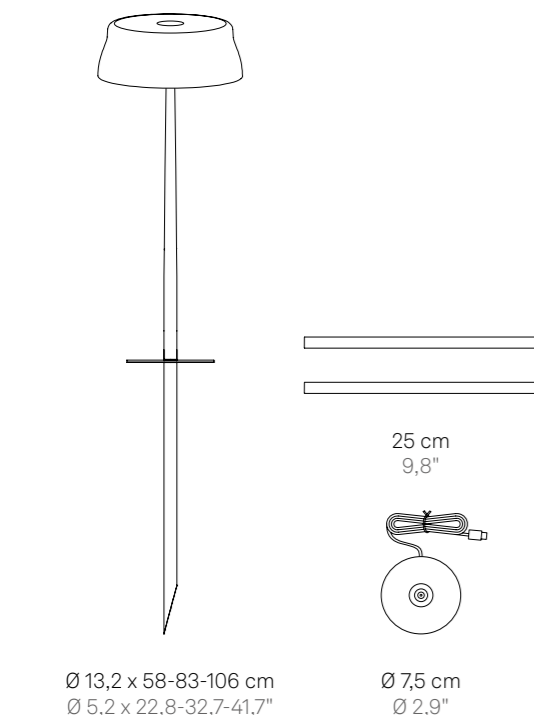

Componenti inclusi

Components included

Base di ricarica a contatto
Contact charging base
Stelo (2 pz.) / Stem (2 pcs.)

Accessori non inclusi

Accessories not included

Caricatore / Charger → **LD0300UC** (pg. 217)
5 V max 2,1 A | 100-240V | USB-A

Finiture

Finishes



LD1083O3

Oro / Gold



LD1083R3

Rame / Copper



LD1083V3

Verde / Green



LD1083B3

Bianco perlato / Pearly white
RAL 9010



LD1083D3

Nero perlato / Pearly black
RAL 9011



LD1083I3

Avorio / Ivory
RAL 1015

Sister Light Wi-Fi^{PRO}

Parete Wall

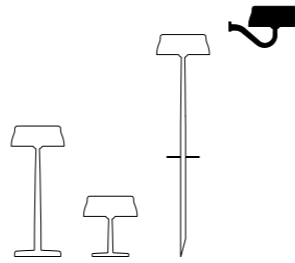

Dati tecnici

Technical data

LED TOUCH DIMMER

2200-2700-3000-4000 K | CRI>90
250-275-296-338 lm | 3,2 W | IP65
5 V max 2A



Corpo in alluminio anodizzato spazzolato (oro, rame, verde) oppure verniciato (bianco perlato, nero perlato, avorio)
Brushed anodized (gold, copper, green) or painted aluminum body (pearly white, pearly black, ivory)

Diffusore in policarbonato prismatico
Prismatic polycarbonate diffuser

Adatta all'uso esterno (lampada IP65) e interno (lampada su base di ricarica IP20)
Suitable for outdoor (lamp IP65) and indoor use (lamp on charging base IP20)

Resistenza agli urti (IK07) e alla nebbia salina (1500h)
Impact resistance (IK07) and salt spray resistance (1500h)

Durata 8 - 36 h, in base alla regolazione del flusso luminoso e alle impostazioni del Wi-Fi
Battery lasts 8 - 36 h, depending on the luminous flux and Wi-Fi setting

Tempo di ricarica a 2A: 5 h
Charging time at 2A: 5 h

Pacco batteria al litio ricaricabile e sostituibile
Rechargeable and replaceable lithium battery pack

Firmware del dispositivo aggiornabile da remoto
Remotely upgradable device firmware

Avvertenze

Remarks

Per poter funzionare, la lampada deve essere collegata a una rete Wi-Fi con frequenza 2,4 GHz.
In order to work, the lamp must be connected to a 2.4 GHz frequency Wi-Fi network.

Accessori non inclusi

Accessories not included

Caricatore / Charger → **LD0300UC** (pg. 217)
5 V max 2,1 A | 100-240V | USB-A

Componenti inclusi

Components included

Base di ricarica a contatto
Contact charging base

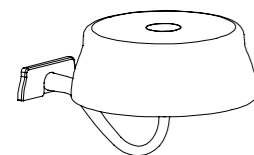

18 x 13,2 x 9,8 cm
7,1 x 5,2 x 3,9"

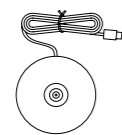

Ø 7,5 cm
Ø 2,9"

Finiture Finishes



LD108203
Oro / Gold



LD1082R3
Rame / Copper



LD1082V3
Verde / Green



LD1082B3
Bianco perlato / Pearly white
RAL 9010



LD1082D3
Nero perlato / Pearly black
RAL 9011



LD1082I3
Avorio / Ivory
RAL 1015



Sister Light Wi-Fi wall lamp
green → **LD1082V3**

Poldina ^{PRO}

Poldina è una collezione di lampade a batteria, portatili e ricaricabili, disponibile nei modelli da tavolo (quattro varianti), da terra (due varianti), a picchetto, a sospensione e a parete (due varianti).

Nella parte superiore della testa della lampada è presente un controllo "touch", che permette l'accensione, la regolazione dell'intensità luminosa e la selezione della temperatura di colore della luce. Grazie a un alto indice di protezione, le lampade sono utilizzabili anche all'esterno (ad eccezione dei modelli con finitura a foglia metallica, finitura craquelé e finitura galvanica). Possiedono un sistema di controllo elettronico che monitora e segnala l'autonomia residua della batteria, permettendo di ottimizzare le ricariche ed effettuarle sempre in maniera corretta. Tutti i modelli sono dotati di base di ricarica a contatto. È possibile personalizzare le lampade con cover in ceramica, acquistabile separatamente (pag. 62).

Poldina is a collection of rechargeable battery-powered cordless luminaires, consisting of table lamps (four versions), floor lamps (two versions), lamp with peg, suspension lamp and wall lamps (two versions).

A "touch" control on the head allows switching on/off, dimming, and selecting the color temperature of the light. It is suitable for both indoor and outdoor use (except leaf finishes, craquelé finishes and galvanic finishes). An electronic control system monitors the remaining autonomy and ensures a constant luminous flux until the battery runs out. Recharging is therefore optimized and always properly done. All models are equipped with contact charging base. The lamps can be personalised with a ceramic cover, available separately (pg. 62).

TAVOLO / MINI TAVOLO / MICRO TAVOLO / L DESK TAVOLO / L TERRA-TAVOLO / XXL TERRA-TAVOLO /
PICCHETTO / SOSPENSIONE / PARETE / ACCESSORI
TABLE / MINI TABLE / MICRO TABLE / L DESK TABLE / L FLOOR-TABLE / XXL FLOOR-TABLE /
LAMP WITH PEG / SUSPENSION / WALL / ACCESSORIES



LINK TO VIDEO



Poldina table lamp
dark green → **LD0340M3**



Poldina mini table lamp
corten → **LD0320R3**



Poldina micro table lamp glossy gold → **LD049003**
Poldina table lamp white → **LD0340B3**

Poldina L desk table
lamp white → **LD0395B3**



Poldina L floor-table lamp
white → **LD0390B3**





Poldina XXL floor-table lamp
dark gray → **LD0360N3**



Poldina lamp with peg
white → **LD0682B3**



Poldina wall lamp
dark gray → **LD0688N3**



Poldina suspension lamp
white → **LD0686B3**

Poldina^{PRO}

Tavolo Table

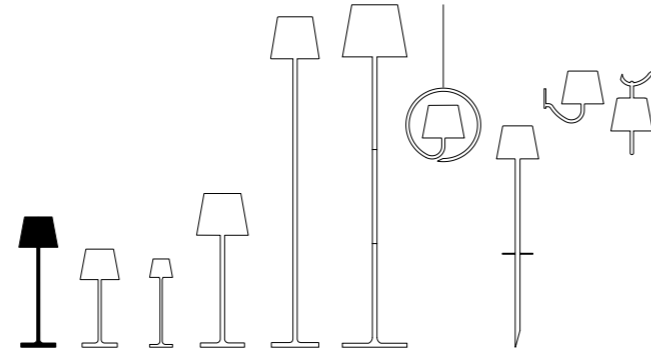

Dati tecnici Technical data

LED TOUCH DIMMER

2200-2700-3000 K | CRI>80
234-251-256 lm | 2,2 W | IP65
50-60 Hz | 5 V max 1A



Corpo in pressofusione di alluminio verniciato
Painted die-cast aluminum body

Schermo diffusore in policarbonato
Polycarbonate diffuser

Adatta all'uso esterno (lampada IP65) e interno (lampada su base di ricarica IP20)
Suitable for outdoor (lamp IP65) and indoor use (lamp on charging base IP20)

Durata di circa 12 h alla massima potenza
Battery lasts about 12 h at full power

Tempo di ricarica a 1A: 6/7 h
Charging time at 1A: 6/7 h

Pacco batteria al litio ricaricabile e sostituibile
Rechargeable and replaceable lithium battery pack

Avvertenze Remarks

Le lampade con finitura in foglia (oro, argento, rame), con finitura craquelé e con finitura lucida (oro e cromo) non sono adatte per uso esterno.
The lamps with leaf finishes (gold, silver and copper), craquelé finish and with glossy finishes (gold and chrome) are not suitable for outdoor use.

Per effetto della natura manuale della tecnica adottata nella lavorazione con foglia metallica, l'aspetto finale della finitura delle lampade può risultare differente. Eventuali difformità attestano il pregio e l'unicità di ciascuna lampada e non vanno considerate come imperfezioni.
Due to the manual nature of the technique adopted in the application of the metal foil, the final appearance of the lamps' finishing can be different. Any apparent imperfections attest to the quality and exclusivity of each lamp and should not be considered as imperfections.

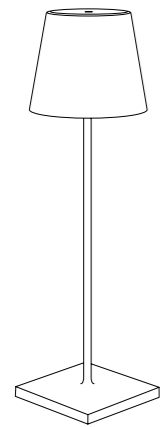

Ø 11 x 38 cm
Ø 4,3 x 15"

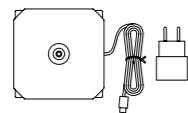

9,4 x 9,4 cm
3,7" x 3,7"

Componenti inclusi Components included

Base di ricarica a contatto e caricatore
Contact charging base and charger

Finiture Finishes



LD0340B3
Bianco / White
RAL 9003



LD0340R3
Corten



LD0340N3
Grigio scuro / Dark gray



LD0340D3
Nero / Black
RAL 9004



LD0340S3
Sabbia / Sand



LD0340G3
Salvia / Sage green
Pantone 5635 U



LD0340P3
Rosa / Pink
Pantone 698 U



LD0340F3
Rosso / Red
RAL 3000

Finiture
Finishes



LD0340A3
Blu avio / Avio blue
Pantone 7468 U



LD0340X3
Bordeaux / Burgundy
RAL 3005



LD0340M3
Verde scuro / Dark green
RAL 6005



LD034003 *
Oro lucido
Glossy gold
Galvanic finish



LD0340C3 *
Cromo lucido
Glossy chrome
Galvanic finish

Finiture
Finishes



LD0340BFO *
Foglia color oro
Gold color leaf
RAL 9003



LD0340BFA *
Foglia color argento
Silver color leaf
RAL 9003



LD0340RFR *
Foglia color rame
Copper color leaf
RAL 9003



LD0340DFO *
Nero - Foglia color oro
craquelé
Black - Gold color leaf
RAL 9004



LD0340AFO *
Blu avio - Foglia color
oro craquelé / Avio blue -
Gold color leaf craquelé
Pantone 7468 U



LD0340FFO *
Rosso - Foglia color oro
craquelé / Red - Gold
color leaf craquelé
RAL 3000

* Le lampade con finitura lucida (oro e cromo) non sono adatte per uso esterno.
* The lamps with glossy finishes (gold and chrome) are not suitable for outdoor use.

* Le lampade con finitura in foglia (oro, argento, rame) e con finitura craquelé non sono adatte per uso esterno.
* The lamps with leaf finishes (gold, silver, copper) and craquelé finishes are not suitable for outdoor use.

poldina x PEANUTS

Tavolo Table

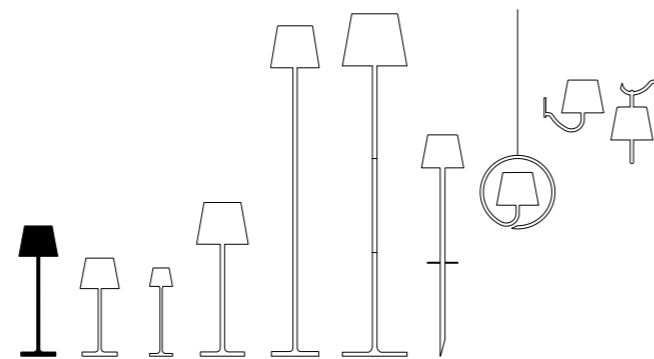

Dati tecnici Technical data

LED TOUCH DIMMER

2200-2700-3000 K | CRI>80
234-251-256 lm | 2,2 W | IP65
50-60 Hz | 5 V max 1A



Corpo in pressofusione di alluminio verniciato
Painted die-cast aluminum body

Schermo diffusore in policarbonato
Polycarbonate diffuser

Adatta all'uso esterno (lampada IP65) e interno (lampada su base di ricarica IP20)
Suitable for outdoor (lamp IP65) and indoor use (lamp on charging base IP20)

Durata di circa 12 h alla massima potenza
Battery lasts about 12 h at full power

Tempo di ricarica a 1A: 6/7 h
Charging time at 1A: 6/7 h

Pacco batteria al litio ricaricabile e sostituibile
Rechargeable and replaceable lithium battery pack

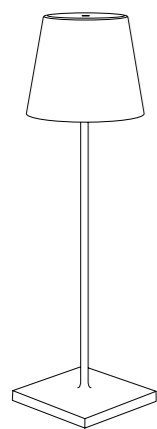

Ø 11 x 38 cm
Ø 4,3 x 15"

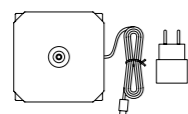

9,4 x 9,4 cm
3,7" x 3,7"



Componenti inclusi Components included

Base di ricarica a contatto e caricatore
Contact charging base and charger

Finiture Finishes



LD0340FP1
Aviator
RAL 3000



LD0340BP2
Heart
RAL 9003



LD0340BP3
Friends
RAL 9003



LD0340BP4
Strip
RAL 9003



LD0340RP5
Together



Poldina^{PRO}

Mini tavolo Mini table

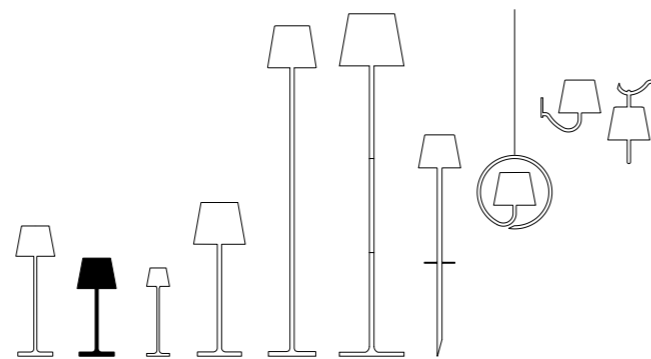

Dati tecnici

Technical data

LED TOUCH DIMMER

2200-2700-3000 K | CRI>80
234-251-256 lm | 2,2 W | IP65
50-60 Hz | 5 V max 1A



Corpo in pressofusione di alluminio verniciato
Painted die-cast aluminum body

Schermo diffusore in policarbonato
Polycarbonate diffuser

Adatta all'uso esterno (lampada IP65) e interno
(lampada su base di ricarica IP20)
Suitable for outdoor (lamp IP65) and indoor use
(lamp on charging base IP20)

Durata di circa 12 h alla massima potenza
Battery lasts about 12 h at full power

Tempo di ricarica a 1A: 6/7 h
Charging time at 1A: 6/7 h

Pacco batteria al litio ricaricabile e sostituibile
Rechargeable and replaceable lithium battery pack

Avvertenze

Remarks

Le lampade con finitura in foglia (oro, argento, rame) e con finitura lucida (oro e cromo) non sono adatte per uso esterno.
The lamps with leaf finishes (gold, silver and copper), and with glossy finishes (gold and chrome) are not suitable for outdoor use.

Per effetto della natura manuale della tecnica adottata nella lavorazione con foglia metallica, l'aspetto finale della finitura delle lampade può risultare differente. Eventuali difformità attestano il pregio e l'unicità di ciascuna lampada e non vanno considerate come imperfezioni.
Due to the manual nature of the technique adopted in the application of the metal foil, the final appearance of the lamps' finishing can be different. Any apparent imperfections attest to the quality and exclusivity of each lamp and should not be considered as imperfections.

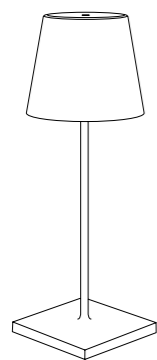

Ø 11 x 30 cm
Ø 4,3 x 11,8"

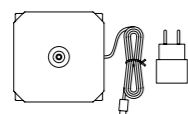

9,4 x 9,4 cm
3,7" x 3,7"

Componenti inclusi

Components included

Base di ricarica a contatto
Contact charging base

Caricabatterie / Charger
100-240 V | USB-A



Poldina mini table
lamp dark gray
→ LD0320N3

Finiture
Finishes



LD0320B3
Bianco / White
RAL 9003

LD0320R3
Corten

LD0320N3
Grigio scuro / Dark gray

LD0320S3
Sabbia / Sand

Finiture
Finishes



LD0320BFO *
Foglia color oro
Gold color leaf
RAL 9003

LD0320BFA *
Foglia color argento
Silver color leaf
RAL 9003

LD0320RFR *
Foglia color rame
Copper color leaf



Poldina table lamp dark gray → **LD0340N3**
Poldina mini table lamp dark gray → **LD0320N3**
Poldina micro table lamp dark gray → **LD0490N3**



LD0320O3 *
Oro lucido
Glossy gold
Galvanic finish

LD0320C3 *
Cromo lucido
Glossy chrome
Galvanic finish

* Le lampade con finitura in foglia (oro, argento, rame) e con finitura lucida (oro e cromo) non sono adatte per uso esterno.
Le lampade con finitura oro lucido e cromo lucido sono dotate della funzione di selezione della temperatura di colore della luce tra 2700 e 3000 K.
* The lamps with leaf finishes (gold, silver, and copper) and glossy finishes (gold, chrome) are not suitable for outdoor use.
The lamps with glossy gold and glossy chrome finish are equipped with a light color temperature selection function 2700 or 3000 K.

Poldina^{PRO}

Micro tavolo Micro table

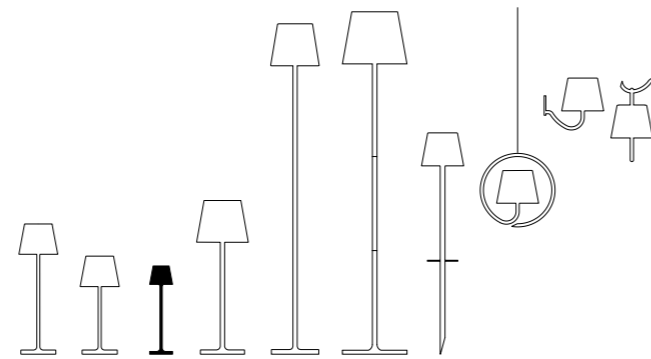

Dati tecnici

Technical data

LED TOUCH DIMMER

2200-2700-3000 K | CRI>80
174-177-195 lm | 1,8 W | IP65
5 V max 1A



Corpo in pressofusione di alluminio verniciato
Painted die-cast aluminum body

Schermo diffusore in policarbonato
Polycarbonate diffuser

Adatta all'uso esterno (lampada IP65) e interno
(lampada su base di ricarica IP20)
Suitable for outdoor (lamp IP65) and indoor use
(lamp on charging base IP20)

Durata di circa 7/8 h alla massima potenza
Battery lasts about 7/8 h at full power

Tempo di ricarica a 1A: 3 h
Charging time at 1A: 3 h

Pacco batteria al litio ricaricabile e sostituibile
Rechargeable and replaceable lithium battery pack

Avvertenze

Remarks

Le lampade con finitura lucida (oro e cromo) e con finitura craquelé non sono adatte per uso esterno.
The lamps with glossy finishes (gold and chrome) and craquelé finishes are not suitable for outdoor use.

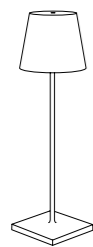

Ø 7 x 27,5 cm
Ø 2,8 x 10,8"

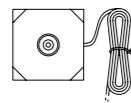

6,7 x 6,7 cm
2,6" x 2,6"

Componenti inclusi

Components included

Base di ricarica a contatto
Contact charging base

Accessori non inclusi

Accessories not included

Caricatore / Charger → **LD0490UA** (pg. 217)
5 V max 1A | 100-240V | USB-A



Premio Barawards 2022
Innovazione dell'Anno

Barawards 2022 Innovation
of the Year Award



Poldina micro table lamp red
→ **LD0490F3**

Finiture
Finishes



LD0490B3
Bianco / White
RAL 9003



LD0490R3
Corten



LD0490N3
Grigio scuro / Dark gray



LD0490D3
Nero / Black
RAL 9004



LD0490S3
Sabbia / Sand



LD0490G3
Salvia / Sage green
Pantone 5635 U



LD0490P3
Rosa / Pink
Pantone 698 U



LD0490F3
Rosso / Red
RAL 3000



LD0490K3
Blu Capri / Capri blue
RAL 5019



LD0490L3
Lilla / Lilac
RAL 4005



LD0490V3
Verde mela / Apple green
RAL 6018



LD0490Z3
Arancio / Orange
RAL 2008

Finiture
Finishes



LD0490O3 *
Oro lucido
Glossy gold
Galvanic finish



LD0490C3 *
Cromo lucido
Glossy chrome
Galvanic finish



LD0490DFO *
Nero - Foglia color oro
craquelé
Black - Gold color leaf
craquelé
RAL 9004



LD0490KFO *
Blu Capri - Foglia color
oro craquelé
Capri blue - Gold color
leaf craquelé
RAL 5019



LD0490FFO *
Rosso - Foglia color oro
craquelé
Red - Gold color leaf
craquelé
RAL 3000

* Le lampade con finitura lucida (oro e cromo) e con finitura craquelé non sono adatte per uso esterno.
* The lamps with glossy finishes (gold and chrome) and with craquelé finishes are not suitable for outdoor use.

Poldina^{PRO}

L desk tavolo L desk table

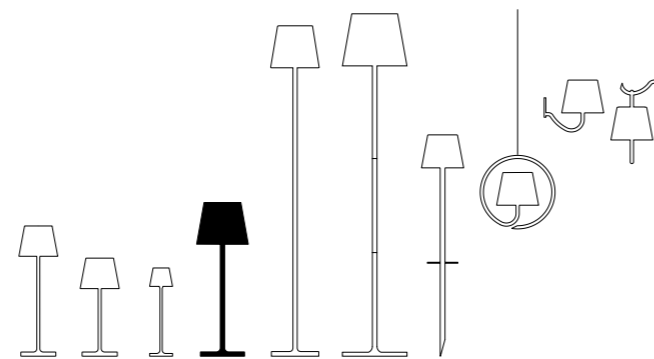

Dati tecnici

Technical data

LED TOUCH DIMMER

2200-2700-3000 K | CRI>80
479- 540-550 lm | 5,5 W | IP54
50-60 Hz | 5 V max 1A



Corpo in pressofusione di alluminio verniciato
Painted die-cast aluminum body

Schermo diffusore in policarbonato
Polycarbonate diffuser

Adatta all'uso esterno (lampada IP54) e interno
(lampada su base di ricarica IP20)
Suitable for outdoor (lamp IP54) and indoor use
(lamp on charging base IP20)

Durata di circa 11 h alla massima potenza
Battery lasts about 11 h at full power

Tempo di ricarica a 1A: 11 h
Charging time at 1A: 11 h

Pacco batteria al litio ricaricabile e sostituibile
Rechargeable and replaceable lithium battery pack

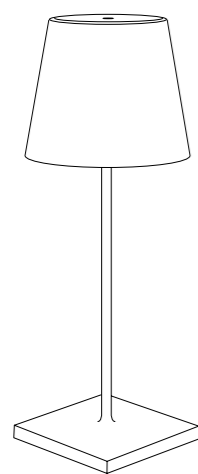

Ø 16,5 x 49,7 cm
Ø 6,5 x 19,6"

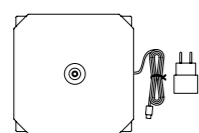

13,5 x 13,5 cm
5,3" x 5,3"

Componenti inclusi Components included

Base di ricarica a contatto
Contact charging base

Caricabatterie / Charger
100-240 V | USB-A

Finiture Finishes



LD0395B3
Bianco / White
RAL 9003



LD0395R3
Corten



LD0395N3
Grigio scuro / Dark gray



Poldina^{PRO}

L terra-tavolo L floor-table

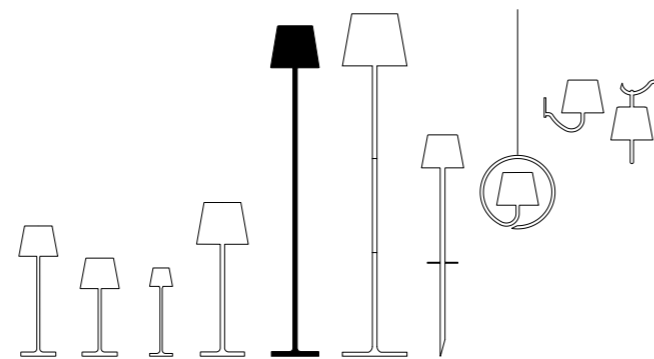

Dati tecnici

Technical data

LED TOUCH DIMMER

2200-2700-3000 K | CRI>80
479- 540-550 lm | 5,5 W | IP54
50-60 Hz | 5 V max 1A



Corpo in pressofusione di alluminio verniciato
Painted die-cast aluminum body

Schermo diffusore in policarbonato
Polycarbonate diffuser

Adatta all'uso esterno (lampada IP54) e interno
(lampada su base di ricarica IP20)
Suitable for outdoor (lamp IP54) and indoor use
(lamp on charging base IP20)

Durata di circa 11 h alla massima potenza
Battery lasts about 11 h at full power

Tempo di ricarica a 1A: 11 h
Charging time at 1A: 11 h

Pacco batteria al litio ricaricabile e sostituibile
Rechargeable and replaceable lithium battery pack

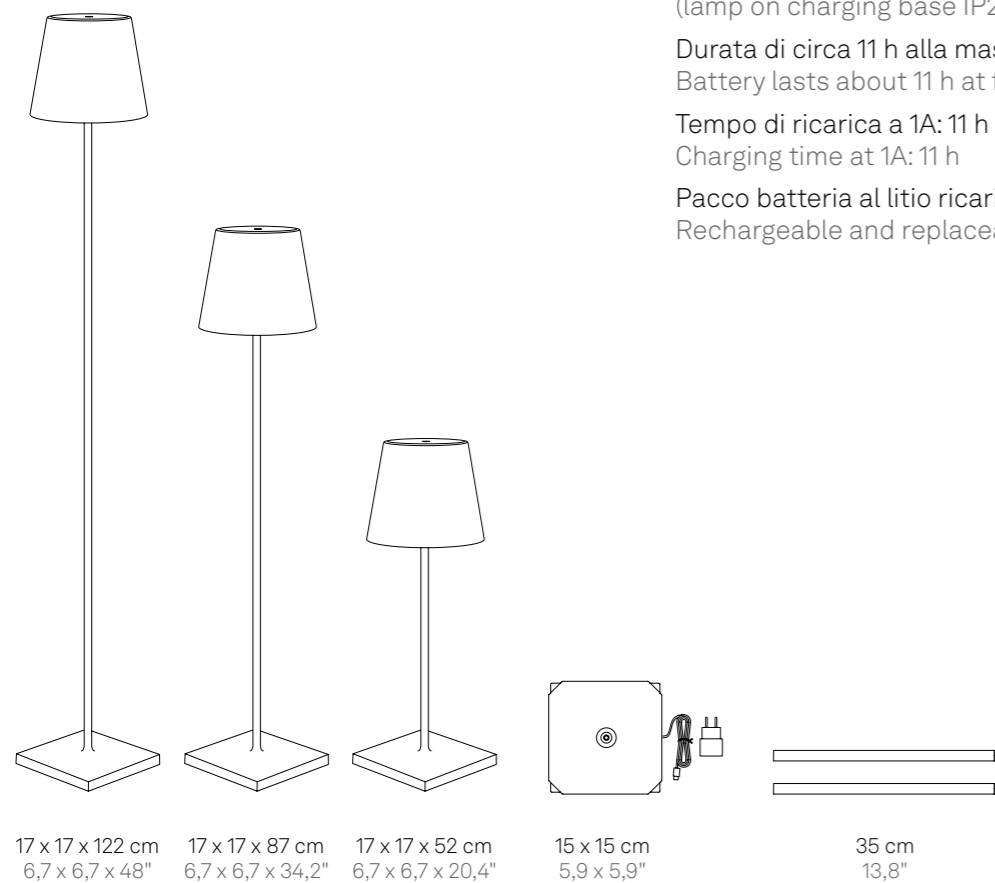

17 x 17 x 122 cm
6,7 x 6,7 x 48"

17 x 17 x 87 cm
6,7 x 6,7 x 34,2"

17 x 17 x 52 cm
6,7 x 6,7 x 20,4"

15 x 15 cm
5,9 x 5,9"

35 cm
13,8"

Componenti inclusi

Components included

Base di ricarica a contatto
Contact charging base

Caricabatterie
Charger
100-240 V | USB-A

Stelo (2 pz.)
Stem (2 pcs.)

Finiture

Finishes



LD0390B3
Bianco / White
RAL 9003



LD0390R3
Corten



LD0390N3
Grigio scuro / Dark gray

Poldina^{PRO}

XXL terra-tavolo XXL floor-table

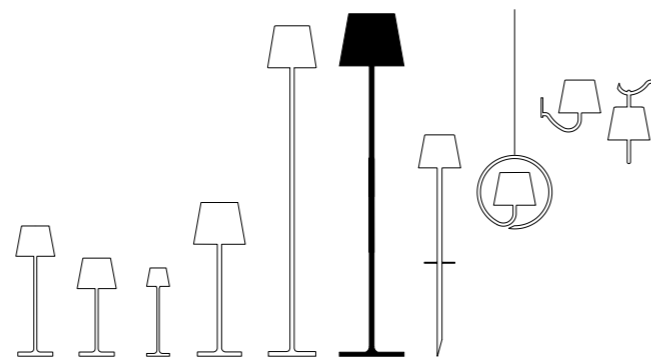

Dati tecnici

Technical data

LED TOUCH DIMMER

2700-3000 K | CRI>80
470-500 lm | 6,5 W | IP54
50-60 Hz | 5 V max 1A



Corpo in pressofusione di alluminio verniciato
Painted die-cast aluminum body

Schermo diffusore in policarbonato
Polycarbonate diffuser

Adatta all'uso esterno (lampada IP54) e interno (lampada su base di ricarica IP20)
Suitable for outdoor (lamp IP54) and indoor use (lamp on charging base IP20)

Durata di circa 15 h alla massima potenza
Battery lasts about 15 h at full power

Tempo di ricarica a 1A: 20 h
Charging time at 1A: 20 h

Pacco batteria al litio ricaricabile e sostituibile
Rechargeable and replaceable lithium battery pack



Ø 28 x 150 cm
Ø 11 x 59,1"

Ø 28 x 110 cm
Ø 11 x 43,3"

Ø 28 x 69,5 cm
Ø 11 x 27,3"

Ø 24,7 cm
Ø 9,7"

40 cm
15,7"

Componenti inclusi

Components included

Base di ricarica a contatto
Contact charging base

Caricabatterie
Charger
100-240 V | USB-A

Stelo (2 pz.)
Stem (2 pcs.)

Finiture

Finishes



LD0360B3
Bianco / White
RAL 9003



LD0360R3
Corten



LD0360N3
Grigio scuro / Dark gray

Poldina^{PRO}

Picchetto Lamp with peg

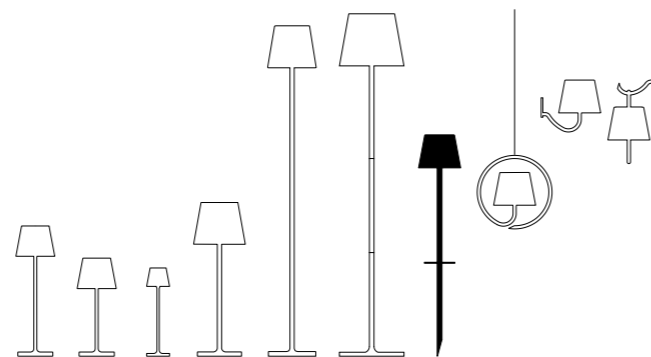

Dati tecnici Technical data

LED TOUCH DIMMER

2200-2700-3000 K | CRI>80
234-251-256 lm | 2,2 W | IP54
5 V max 1A



Corpo in pressofusione di alluminio verniciato
Painted die-cast aluminum body

Schermo diffusore in policarbonato
Polycarbonate diffuser

Adatta all'uso esterno (lampada IP54) e interno (lampada su base di ricarica IP20)
Suitable for outdoor (lamp IP54) and indoor use (lamp on charging base IP20)

Durata di circa 12 h alla massima potenza
Battery lasts about 12 h at full power

Tempo di ricarica a 1A: 6/7 h
Charging time at 1A: 6/7 h

Pacco batteria al litio ricaricabile e sostituibile
Rechargeable and replaceable lithium battery pack

Avvertenze

Remarks

La stabilità della lampada è garantita con l'uso di massimo tre prolunghe
The stability of the lamp is guaranteed when using three extensions maximum

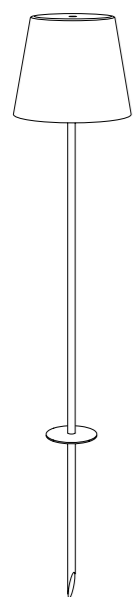

Ø 11 x 60 cm
Ø 4,3 x 23,6"

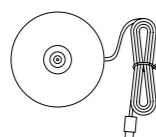

Ø 10,2 cm
Ø 4"

Componenti inclusi Components included

Base di ricarica a contatto
Contact charging base

Accessori non inclusi Accessories not included

Caricatore / Charger → **LD0490UA** (pg. 217)
5 V max 1A | 100-240V | USB-A
Prolunga stelo aggiuntiva
Additional stem extension

Finiture Finishes



LD0682B3
Bianco / White
RAL 9003



LD0682R3
Corten



LD0682N3
Grigio scuro / Dark gray

Prolunga stelo aggiuntiva (non inclusa) Additional stem extension (not included)

25 cm
9,8"

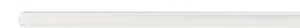

LD0283B3
Bianco / White
RAL 9003

25 cm
9,8"



LD0283R3
Corten

25 cm
9,8"



LD0283N3
Grigio scuro / Dark gray

Poldina^{PRO}

Sospensione Suspension

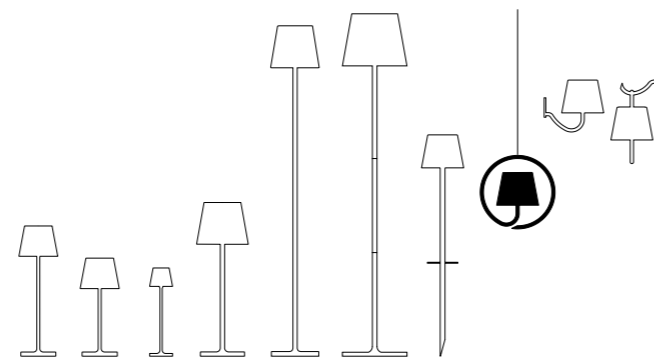

Dati tecnici

Technical data

LED TOUCH DIMMER

2200-2700-3000 K | CRI>80
234-251-256 lm | 2,2 W | IP54
5 V max 1A



Corpo in pressofusione di alluminio verniciato
Painted die-cast aluminum body

Schermo diffusore in policarbonato
Polycarbonate diffuser

Adatta all'uso esterno (lampada IP54) e interno
(lampada su base di ricarica IP20)
Suitable for outdoor (lamp IP54) and indoor use
(lamp on charging base IP20)

Durata di circa 12 h alla massima potenza
Battery lasts about 12 h at full power

Tempo di ricarica a 1A: 6/7 h
Charging time at 1A: 6/7 h

Pacco batteria al litio ricaricabile e sostituibile
Rechargeable and replaceable lithium battery pack

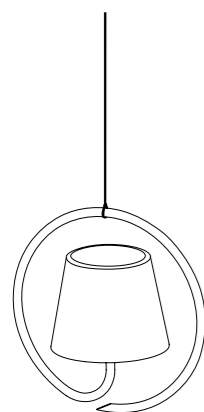

19,8 x 19,8 x 11 cm
7,8 x 7,8 x 4,3"

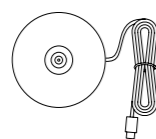

Ø 10,2 cm
Ø 4"

Componenti inclusi

Components included

Base di ricarica a contatto
Contact charging base

Accessori non inclusi

Accessories not included

Caricatore / Charger → **LD0490UA** (pg. 217)
5 V max 1A | 100-240V | USB-A

Finiture

Finishes



LD0686B3

Bianco / White
RAL 9003



LD0686R3

Corten



LD0686N3

Grigio scuro / Dark gray



Poldina suspension lamp
dark gray → **LD0686N3**

Poldina^{PRO}

Parete Wall

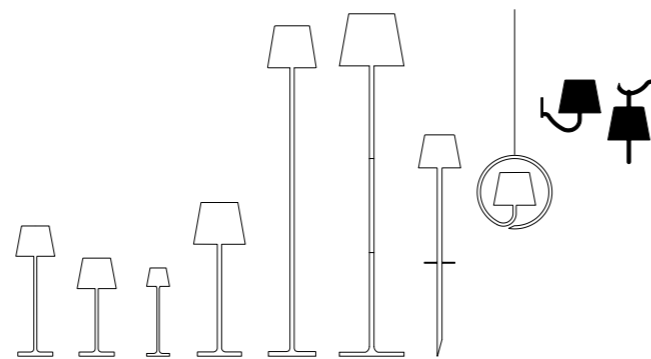

Dati tecnici

Technical data

LED TOUCH DIMMER

2200-2700-3000 K | CRI>80
234-251-256 lm | 2,2 W | IP54
5 V max 1A



Corpo in pressofusione di alluminio verniciato
Painted die-cast aluminum body

Schermo diffusore in policarbonato
Polycarbonate diffuser

Adatta all'uso esterno (lampada IP54) e interno
(lampada su base di ricarica IP20)
Suitable for outdoor (lamp IP54) and indoor use
(lamp on charging base IP20)

Durata di circa 12 h alla massima potenza
Battery lasts about 12 h at full power

Tempo di ricarica a 1A: 6/7 h
Charging time at 1A: 6/7 h

Pacco batteria al litio ricaricabile e sostituibile
Rechargeable and replaceable lithium battery pack

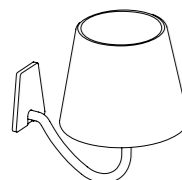

15,8 x 14 x 11 cm
6,2 x 5,5 x 4,3"

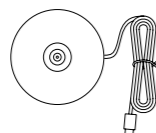

Ø 10,2 cm
Ø 4"

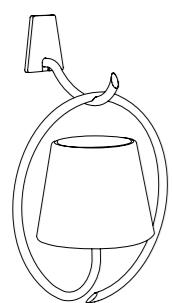

12,3 x 26,5 x 11 cm
4,8 x 10,4 x 4,3"

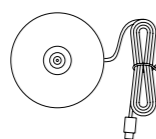

Ø 10,2 cm
Ø 4"

Componenti inclusi

Components included

Base di ricarica a contatto
Contact charging base

Accessori non inclusi

Accessories not included

Caricatore / Charger → **LD0490UA** (pg. 217)
5 V max 1A | 100-240V | USB-A

Finiture

Finishes



LD0688B3

Bianco / White
RAL 9003



LD0688R3

Corten



LD0688N3

Grigio scuro / Dark gray



LD0689B3

Bianco / White
RAL 9003



LD0689R3

Corten



LD0689N3

Grigio scuro / Dark gray

Poldina^{PRO}

Cover in ceramica

Ceramic cover



Dati tecnici

Technical data



Componenti inclusi

Components included

Adesivi
Strips

Video tutorial: montaggio cover
Tutorial video: installation of the cover

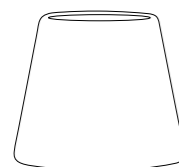

Ø 13 x 10 cm
Ø 5,1" x 3,9"



Ø 8,5 x 6,6 cm
Ø 3,3" x 2,6"



Cover in ceramica che si fissa alla testa della lampada Poldina tramite adesivi. La stretta collaborazione con un'antica fabbrica di Civita Castellana - borgo viterbese dove l'arte della ceramica è attestata fin dal X secolo a.C. – consente a Zafferano di avvalersi di una produzione esclusiva di manufatti "Made in Italy", decorati a mano su disegno proprio o del cliente.

Ceramic cover that is fixed to the head of the lamp with adhesive strips. The close partnership with a historic factory in Civita Castellana - a village near Rome, where the art of ceramics has been practiced since the 10th century BC - allows Zafferano to rely on the exclusive production of made in Italy artifacts, which are hand-painted according to Zafferano design; customization available.



Finiture
Finishes



LD035000 Righe verdi Green stripes	LD035001 Righe gialle Yellow stripes	LD035002 Righe blu Capri Capri blue stripes	LD035003 Righe rosse Red stripes	LD035010 Righe nere Black stripes	LD035004 Pesci azzurri Light blue fish
---	---	--	---	--	---

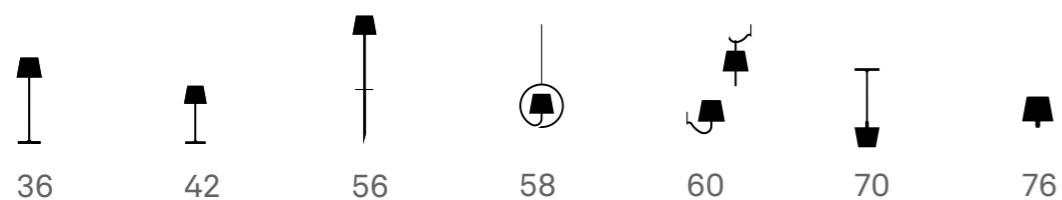

Poldina	Tavolo Table	Mini tavolo Mini table	Picchetto Lamp with peg	Sospensione Suspension	Parete Wall	Poldina Reverso	Poldina Stopper
----------------	-----------------	---------------------------	----------------------------	---------------------------	----------------	----------------------------	----------------------------

Finiture
Finishes



LD049900 Righe verdi Green stripes	LD049902 Righe blu Capri Capri blue stripes	LD049903 Righe rosse Red stripes	LD049905 Righe arancio Orange stripes	LD049910 Righe nere Black stripes	LD049904 Pesci azzurri Light blue fish
---	--	---	--	--	---



Poldina	Micro tavolo Micro table
----------------	-----------------------------



Poldina micro table lamp orange → **LD0490Z3**
 Ceramic cover → **LD049905**
 Poldina micro table lamp red → **LD0490F3**
 Ceramic cover → **LD049903**

Poldina Reverso ^{PRO}

Design Federico de Majo

Poldina Reverso è una lampada da tavolo a batteria, portatile e ricaricabile, con contenitore multiuso. Nella parte inferiore della testa è presente un controllo "touch", che permette l'accensione, la regolazione dell'intensità luminosa e la selezione della temperatura di colore della luce. Grazie a un alto indice di protezione, la lampada è utilizzabile anche all'esterno. Il contenitore multiuso (capacità 18 cl) in resina termoplastica adatta al contatto alimentare (PET) è removibile e riutilizzabile. Possiede un sistema di controllo elettronico che monitora e segnala l'autonomia residua della batteria, permettendo di ottimizzare le ricariche ed effettuarle sempre in maniera corretta. È dotata di base di ricarica a contatto; caricabatterie incluso. È possibile personalizzare la lampada con cover in ceramica, acquistabile separatamente (pag. 62).

Poldina Reverso is a rechargeable battery-powered cordless table lamp, with a multipurpose storage tray. A "touch" control smartly placed on the lower part of the head allows switching on/off, dimming, and selecting the color temperature of the light. It is suitable for both indoor and outdoor use. The multipurpose container tray (capacity 18cl) in thermoplastic resin suitable for food contact (PET) is removable and reusable. An electronic control system monitors the remaining autonomy and ensures a constant luminous flux until the battery runs out. Recharging is therefore optimized and always properly done. The lamp comes with a contact charging base; battery charger included. Poldina Reverso can be customized with a ceramic cover, to be purchased separately (pg. 62).



LINK TO VIDEO

TAVOLO
TABLE



Poldina Reverso table
lamp corten → **LD0420R3**



Poldina Reverso ^{PRO}

Tavolo Table



Dati tecnici

Technical data

LED TOUCH DIMMER

2200-2700-3000 K | CRI>80
241-250-262 lm | 2,3 W | IP54
50-60 Hz | 5 V max 1A

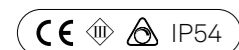

Corpo in pressofusione di alluminio verniciato
Painted die-cast aluminum body

Schermo diffusore in policarbonato satinato
Diffuser in satin-finish polycarbonate

Adatta all'uso esterno (lampada IP54) e interno
(lampada su base di ricarica IP20)
Suitable for outdoor (lamp IP54) and indoor use
(lamp on charging base IP20)

Durata di circa 12 h alla massima potenza
Battery lasts about 12 h at full power

Tempo di ricarica a 1A: 6/7 h
Charging time at 1A: 6/7 h

Pacco batteria al litio ricaricabile e sostituibile
Rechargeable and replaceable lithium battery pack

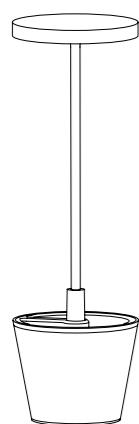

Ø 11 x 35 cm
Ø 4,3 x 13,8"

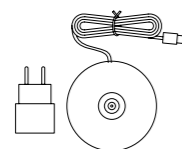

Ø 7,5 cm
Ø 2,9"



Ø 10,5 x 3,7 cm
Ø 4,1 x 1,5"

Componenti inclusi

Components included

Base di ricarica a contatto
Contact charging base

Caricabatterie / Charger
100-240 V | USB-A

Vaschetta contenitore multiuso
Multipurpose container tray

Finiture Finishes



LD0420B3
Bianco / White
RAL 9003

LD0420R3
Corten

LD0420N3
Grigio scuro
Dark gray

LD0420S3
Sabbia / Sand

LD0420G3
Salvia / Sage green
Pantone 5635 U



Poldina Stopper^{PRO}

Poldina Stopper è una lampada a batteria, portatile e ricaricabile, con tappo in silicone, che si può inserire su una bottiglia, trasformandola in un oggetto luminoso. Nella parte superiore della testa è presente un controllo "touch", che permette l'accensione, la regolazione dell'intensità luminosa e la selezione della temperatura di colore della luce. Grazie a un alto indice di protezione, la lampada è utilizzabile anche all'esterno. Possiede un sistema di controllo elettronico che monitora e segnala l'autonomia residua della batteria, permettendo di ottimizzare le ricariche ed effettuarle sempre in maniera corretta. Il tappo in silicone (adatto al contatto alimentare) si adatta a diversi colli di bottiglia e si rimuove in modo pratico, permettendo di ricaricare comodamente la lampada sulla propria base di ricarica a contatto. Caricabatterie non incluso. Poldina Stopper è utilizzabile anche con le bottiglie in ceramica "Lido", acquistabili separatamente (pag. 78).

Poldina Stopper is a rechargeable battery-operated, cordless lamp. Thanks to a silicone stopper cork, the lamp can be placed on a bottle, turning it into a luminous object. A "touch" control on the head allows switching on/off, dimming, and selecting the color temperature of the light. It is suitable for both indoor and outdoor use. An electronic control system monitors the remaining autonomy and ensures a constant luminous flux until the battery runs out. Recharging is therefore optimized and always properly done.

The silicone cap (suitable for food contact) fits different bottle necks and can be easily removed, allowing the lamp to be conveniently recharged on its contact charging base; battery charger not included. Poldina Stopper can also be used with "Lido" ceramic bottles, which can be purchased separately (pg. 78).



LINK TO VIDEO

STOPPER



Poldina Stopper black → **LD0349D3**
Lido ceramic bottle black → **FAS1508**

Poldina Stopper sand → **LD0349S3**
Lido ceramic bottle sand → **FAS1507 + PUN1507**



Poldina Stopper Avio blue → **LD0349A3**
Lido ceramic bottle light blue → **RIG1508**

Poldina Stopper^{PRO}

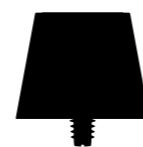

Dati tecnici

Technical data

LED TOUCH DIMMER

2200-2700-3000 K | CRI>80
234-251-256 lm | 2,2 W | IP54
5 V max 1A



Corpo in pressofusione di alluminio verniciato
Painted die-cast aluminum body

Schermo diffusore in policarbonato
Polycarbonate diffuser

Adatta all'uso esterno (lampada IP54) e interno
(lampada su base di ricarica IP20)
Suitable for outdoor (lamp IP54) and indoor use
(lamp on charging base IP20)

Durata di circa 12 h alla massima potenza
Battery lasts about 12 h at full power

Tempo di ricarica a 1A: 6/7 h
Charging time at 1A: 6/7 h

Pacco batteria al litio ricaricabile e sostituibile
Rechargeable and replaceable lithium battery pack

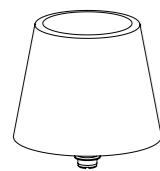

Ø 11,1 x 11,1 cm
Ø 4,4 x 4,4 in

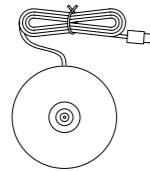

Ø 10,2 cm
Ø 4 in



Ø 2,5 x 3,8 cm
Ø 1 x 1,5 in

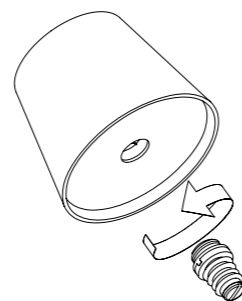

Componenti inclusi

Components included

Base di ricarica a contatto
Contact charging base

Tappo in silicone per Poldina / Poldina silicon cover

Accessori non inclusi

Accessories not included

Caricatore / Charger → **LD0490UA** (pg. 217)
5 V max 1A | 100-240V | USB-A

Finiture

Finishes



LD0349B3
Bianco / White
RAL 9003



LD0349D3
Nero / Black
RAL 9004



LD0349S3
Sabbia / Sand



LD0349G3
Salvia / Sage green
Pantone 5635 U



LD0349A3
Blu avio / Avio blue
Pantone 7468 U



LD0349F3
Rosso / Red
RAL 3000

Lido

Bottiglia in ceramica

Ceramic bottle

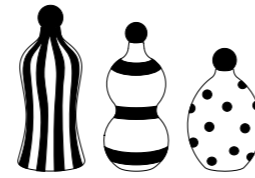

Dati tecnici

Technical data

Ceramica decorata a mano
Hand-painted ceramic

Tappo ermetico, in materiale plastico,
adatto al contatto alimentare
Airtight plastic stopper, suitable for
food contact

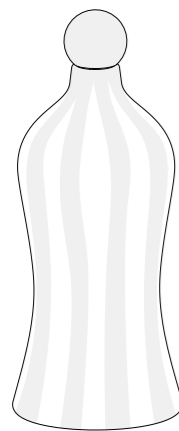

Ø 11 x 26,5 cm
Ø 4,3 x 10,4 in
90 cl

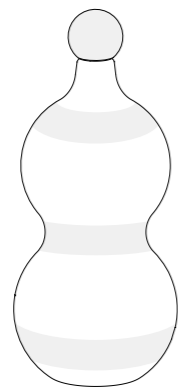

Ø 10,4 x 24,5 cm
Ø 4,1 x 9,6 in
82 cl

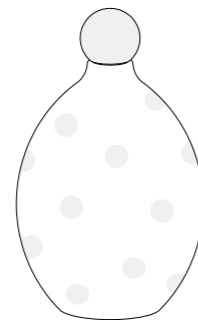

Ø 13 x 20,5 cm
Ø 5,1 x 8,1 in
114 cl

Bottiglia in ceramica, nella cui imboccatura si può alloggiare la lampada Poldina Stopper. È prodotta in tre modelli, diversi tra loro per forma e motivo decorativo; ciascun modello è disponibile in cinque colori, con tappo sferico in tinta.

Ceramic bottle in whose mouth the Poldina Stopper lamp can be placed. It is produced in three models, different in shape and decorative motif; each model is available in five colors, with matching spherical cap.

Finiture Finishes



RIG1501
Righe azzurre
Light blue stripes



RIG1502
Righe rosse
Red stripes



RIG1505
Righe verdi
Green stripes



RIG1507
Righe sabbia
Sand stripes



RIG1508
Righe nere
Black stripes



FAS1501
Fasce azzurre
Light blue bands



FAS1502
Fasce rosse
Red bands



FAS1505
Fasce verdi
Green bands



FAS1507
Fasce sabbia
Sand bands



FAS1508
Fasce nere
Black bands



PUN1501
Pois azzurri
Light blue dots



PUN1502
Pois rossi
Red dots



PUN1505
Pois verdi
Green dots



PUN1507
Pois sabbia
Sand dots



PUN1508
Pois neri
Black dots

Amelie ^{PRO}

Design Sara Moroni



reddot winner 2023

Amelie è una collezione di lampade a batteria, portatili e ricaricabili, che comprende i modelli da tavolo, terra, parete, sospensione e con picchetto. Le lampade da tavolo, terra, parete e con picchetto vengono fornite con un tappo in silicone e un gancio che permettono di trasformarle in una sospensione. Un controllo “touch” presente nella parte superiore della testa permette l'accensione, la regolazione dell'intensità luminosa e la selezione della temperatura di colore della luce. Grazie a un alto indice di protezione, le lampade della collezione sono utilizzabili anche all'esterno. Sono dotate di base di ricarica a contatto. Caricabatterie non incluso.

Amelie is a collection of portable, rechargeable battery-operated lamps that includes the following models: table, floor, wall and suspension lamps, and lamp with peg. The table, floor and wall lamps and lamp with peg are supplied with a silicone cap and a hook, so that they can be transformed into a suspension lamp. On the head, a touch sensor allows you to switch it on, adjust the luminous intensity and select the color temperature of the light. With the high IP rating, the lamps can also be used outdoors.

The lamps come with a contact charging base; battery charger not included.

TAVOLO / TERRA / PICCHETTO / SOSPENSIONE / PARETE
TABLE / FLOOR / LAMP WITH PEG / SUSPENSION / WALL



LINK TO VIDEO



Amelie table lamp
leaf green → LD1090V3



Amelie suspension lamp
black → **LD1091D3**



Amelie wall lamp
white → **LD1092B3**



Amelie lamp with peg
terracotta → **LD1094T3**



Amelie floor lamp
white → **LD1096B3**

Amelie^{PRO}

Tavolo Table

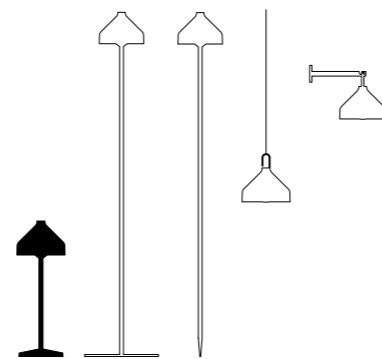

Dati tecnici

Technical data

LED TOUCH DIMMER

2200-2700-3000 K | CRI>80
253-300-308 lm | 3 W | IP65
5 V max 1A



Corpo in pressofusione di alluminio verniciato
Painted die-cast aluminum body

Schermo diffusore in policarbonato opale
Opal polycarbonate diffuser

Adatta all'uso esterno (lampada IP65) e interno
(lampada su base di ricarica IP20)
Suitable for outdoor (lamp IP65) and indoor use
(lamp on charging base IP20)

Durata di circa 10 h alla massima potenza
Battery lasts about 10 h at full power

Tempo di ricarica a 1A: 6 h
Charging time at 1A: 6 h

Pacco batteria al litio ricaricabile e sostituibile
Rechargeable and replaceable lithium battery pack

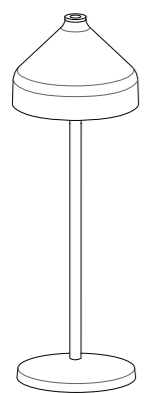

Ø 12 x 34 cm
Ø 4,7 x 13,4"

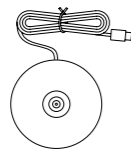

Ø 12 cm
Ø 4,7"

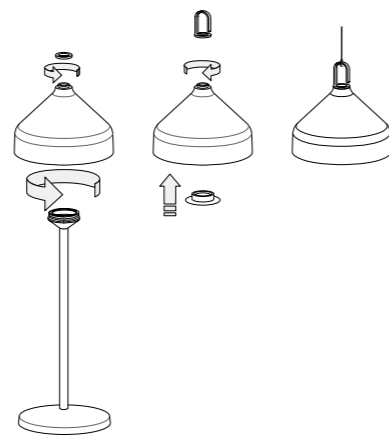

Componenti inclusi

Components included

Base di ricarica a contatto
Contact charging base

Accessorio per utilizzo a sospensione
(tappo in silicone e gancio)
Accessories to use as a suspension lamp
(silicon cap and hook)

Accessori non inclusi

Accessories not included

Caricatore / Charger → **LD0490UA** (pg. 217)
5 V max 1A | 100-240V | USB-A

Finiture

Finishes



LD1090B3
Bianco / White
RAL 9016



LD1090D3
Nero / Black
RAL 9011



LD1090V3
Verde foglia / Leaf green
RAL 150 60 10



LD1090T3
Terracotta
Pantone 49-12 C



Amelie table lamp
terracotta → **LD1090T3**

Amelie^{PRO}

Terra Floor

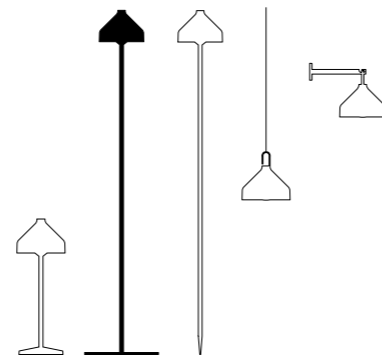

Dati tecnici

Technical data

LED TOUCH DIMMER

2200-2700-3000 K | CRI>80
253-300-308 lm | 3 W | IP65
5 V max 1A

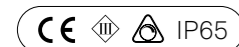

Corpo in pressofusione di alluminio verniciato
Painted die-cast aluminum body

Schermo diffusore in policarbonato opale
Opal polycarbonate diffuser

Adatta all'uso esterno (lampada IP65) e interno (lampada su base di ricarica IP20)
Suitable for outdoor (lamp IP65) and indoor use (lamp on charging base IP20)

Durata di circa 10 h alla massima potenza
Battery lasts about 10 h at full power

Tempo di ricarica a 1A: 6 h
Charging time at 1A: 6 h

Pacco batteria al litio ricaricabile e sostituibile
Rechargeable and replaceable lithium battery pack

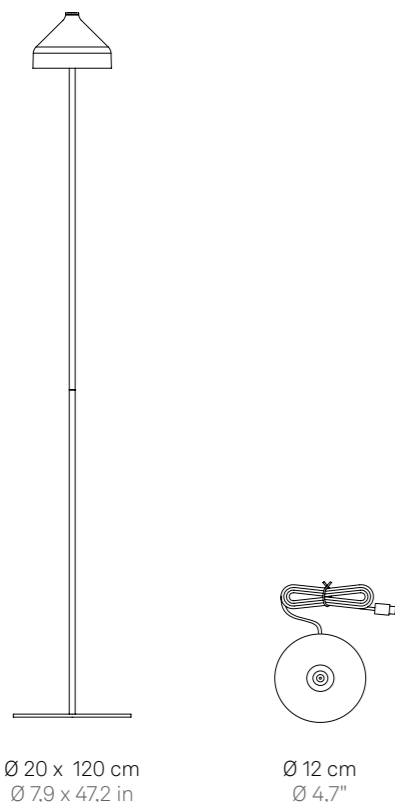

Ø 20 x 120 cm
Ø 7,9 x 47,2 in

Ø 12 cm
Ø 4,7"

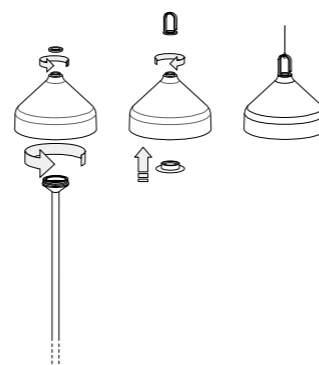

Componenti inclusi

Components included

Base di ricarica a contatto
Contact charging base

Accessorio per utilizzo a sospensione (tappo in silicone e gancio)
Accessories to use as a suspension lamp (silicon cap and hook)

Accessori non inclusi

Accessories not included

Caricatore / Charger → **LD0490UA** (pg. 217)
5 V max 1A | 100-240V | USB-A

Finiture Finishes



LD1096B3
Bianco / White
RAL 9016

LD1096D3
Nero / Black
RAL 9011

LD1096V3
Verde foglia / Leaf green
RAL 150 60 10

LD1096T3
Terracotta
Pantone 49-12 C

Amelie^{PRO}

Picchetto

Lamp with peg

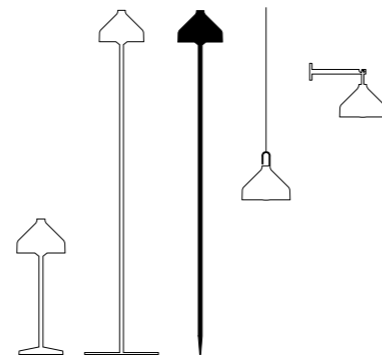

Dati tecnici

Technical data

LED TOUCH DIMMER

2200-2700-3000 K | CRI>80
253-300-308 lm | 3 W | IP65
5 V max 1A



Corpo in pressofusione di alluminio verniciato
Painted die-cast aluminum body

Schermo diffusore in policarbonato opale
Opal polycarbonate diffuser

Adatta all'uso esterno (lampada IP65) e interno (lampada su base di ricarica IP20)
Suitable for outdoor (lamp IP65) and indoor use (lamp on charging base IP20)

Durata di circa 10 h alla massima potenza
Battery lasts about 10 h at full power

Tempo di ricarica a 1A: 6 h
Charging time at 1A: 6 h

Pacco batteria al litio ricaricabile e sostituibile
Rechargeable and replaceable lithium battery pack

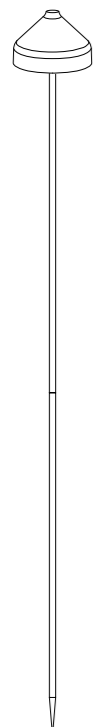

Ø 12 x 120 cm
Ø 4,7 x 47,2"

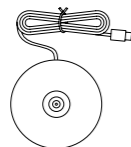

Ø 12 cm
Ø 4,7"

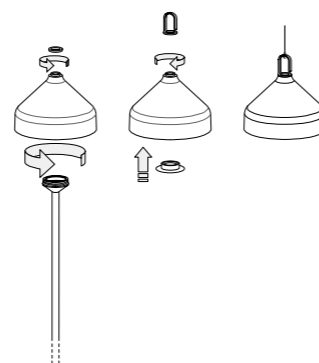

Componenti inclusi

Components included

Base di ricarica a contatto
Contact charging base

Accessorio per utilizzo a sospensione (tappo in silicone e gancio)
Accessories to use as a suspension lamp (silicon cap and hook)

Accessori non inclusi

Accessories not included

Caricatore / Charger → **LD0490UA** (pg. 217)
5 V max 1A | 100-240V | USB-A

Finiture

Finishes



LD1094B3
Bianco / White
RAL 9016

LD1094D3
Nero / Black
RAL 9011

LD1094V3
Verde foglia / Leaf green
RAL 150 60 10

LD1094T3
Terracotta
Pantone 49-12 C

Amelie^{PRO}

Sospensione Suspension

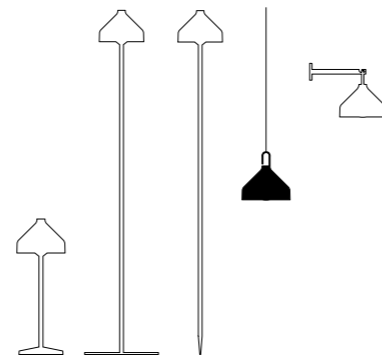

Dati tecnici

Technical data

LED TOUCH DIMMER

2200-2700-3000 K | CRI>80
253-300-308 lm | 3 W | IP65
5 V max 1A

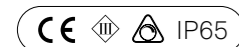

Corpo in pressofusione di alluminio verniciato
Painted die-cast aluminum body

Schermo diffusore in policarbonato opale
Opal polycarbonate diffuser

Adatta all'uso esterno (lampada IP65) e interno
(lampada su base di ricarica IP20)
Suitable for outdoor (lamp IP65) and indoor use
(lamp on charging base IP20)

Durata di circa 10 h alla massima potenza
Battery lasts about 10 h at full power

Tempo di ricarica a 1A: 6 h
Charging time at 1A: 6 h

Pacco batteria al litio ricaricabile e sostituibile
Rechargeable and replaceable lithium battery pack

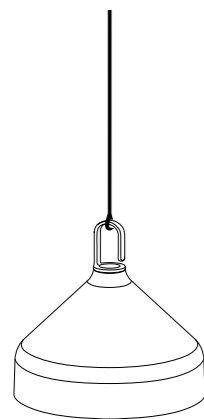

Ø 12 x 12 cm
Ø 4,7 x 4,7"

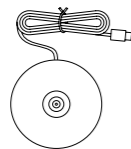

Ø 12 cm
Ø 4,7"

Componenti inclusi

Components included

Base di ricarica a contatto
Contact charging base

Tappo in silicone e gancio
Silicon cap and hook

Accessori non inclusi

Accessories not included

Caricatore / Charger → **LD0490UA** (pg. 217)
5 V max 1A | 100-240V | USB-A

Finiture

Finishes



LD1091B3

Bianco / White
RAL 9016

LD1091D3

Nero / Black
RAL 9011

LD1091V3

Verde foglia / Leaf green
RAL 150 60 10

LD1091T3

Terracotta
Pantone 49-12 C



Amelie^{PRO}

Parete Wall

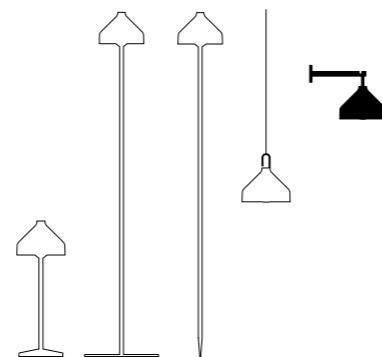

Dati tecnici

Technical data

LED TOUCH DIMMER

2200-2700-3000 K | CRI>80
253-300-308 lm | 3 W | IP65
5 V max 1A



Corpo in pressofusione di alluminio verniciato
Painted die-cast aluminum body

Schermo diffusore in policarbonato opale
Opal polycarbonate diffuser

Adatta all'uso esterno (lampada IP65) e interno
(lampada su base di ricarica IP20)
Suitable for outdoor (lamp IP65) and indoor use
(lamp on charging base IP20)

Durata di circa 10 h alla massima potenza
Battery lasts about 10 h at full power

Tempo di ricarica a 1A: 6 h
Charging time at 1A: 6 h

Pacco batteria al litio ricaricabile e sostituibile
Rechargeable and replaceable lithium battery pack

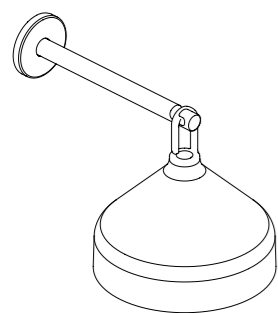

20 x 14 x 12 cm
7,9 x 5,5 x 4,7"

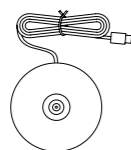

Ø 12 cm
Ø 4,7"

Componenti inclusi

Components included

Base di ricarica a contatto
Contact charging base

Tappo in silicone e gancio
Silicon cap and hook

Accessori non inclusi

Accessories not included

Caricatore / Charger → **LD0490UA** (pg. 217)
5 V max 1A | 100-240V | USB-A

Finiture

Finishes



LD1092B3

Bianco / White
RAL 9016

LD1092D3

Nero / Black
RAL 9011

LD1092V3

Verde foglia / Leaf green
RAL 150 60 10

LD1092T3

Terracotta
Pantone 49-12 C



Amelie wall lamp
black → **LD1092D3**

Circe^{PRO}

Circe è una lampada da tavolo a batteria, portatile e ricaricabile. Nella parte superiore della testa è presente un pulsante che permette l'accensione, la regolazione dell'intensità luminosa e la selezione della temperatura di colore della luce (bianco dinamico). Grazie ad un alto indice di protezione, la lampada è utilizzabile anche all'esterno (ad eccezione dei modelli con finitura galvanica). È dotata di base di ricarica a contatto. Caricabatterie non incluso.

Circe is a rechargeable battery-powered cordless table lamp. The knob on the top of the lampshade allows switching on/off, dimming, and tuning the color temperature of the light (Tunable CCT). It is suitable for both indoor and outdoor use (except galvanic finishes). Circe comes with a contact charging base; the battery charger is not included.

TAVOLO
TABLE



LINK TO VIDEO



Circe table lamp
corten → LD1005R3



Circe table lamp
corten → **LD1005R3**

Circe table lamp glossy
copper → **LD1005E3**



Circe^{PRO}

Tavolo Table



Dati tecnici

Technical data

LED DIMMER

Bianco dinamico / Tunable CCT
(2200-3000 K) | CRI>80
214-224 lm | 2,2 W | IP65
5 V max 1A



Corpo in pressofusione di alluminio verniciato
Painted die-cast aluminum body

Schermo diffusore in policarbonato prismatico
Prismatic polycarbonate diffuser

Adatta all'uso esterno (lampada IP65) e interno
(lampada su base di ricarica IP20)
Suitable for outdoor (lamp IP65) and indoor use
(lamp on charging base IP20)

Durata di circa 9 h alla massima potenza
Battery lasts about 9 h at full power

Tempo di ricarica a 1A: 6 h
Charging time at 1A: 6 h

Pacco batteria al litio ricaricabile e sostituibile
Rechargeable and replaceable lithium battery pack

Avvertenze

Remarks

Le lampade con finitura lucida (oro e rame) non sono
adatte per uso esterno.
The lamps with glossy finishes (gold and copper)
are not suitable for outdoor use.

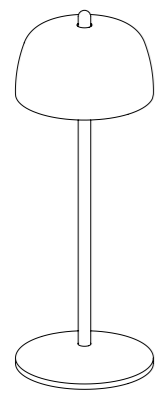

Ø 11 x 30 cm
Ø 4,3 x 11,8"

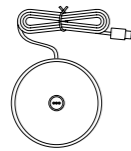

Ø 11,6 cm
Ø 4,5"

Accessori inclusi

Accessories included

Base di ricarica a contatto
Contact charging base

Accessori non inclusi

Accessories not included

Caricatore / Charger → **LD0490UA** (pg. 217)
5 V max 1A | 100-240V | USB-A

Finiture

Finishes



LD1005B3
Bianco / White
RAL 9002



LD1005R3
Corten



LD1005N3
Nero / Black
RAL 9005



LD100503 *
Oro lucido / Glossy gold
Galvanic finish



LD1005E3 *
Rame lucido / Glossy copper
Galvanic finish

* Le lampade con finitura lucida (oro e rame) non sono adatte per uso esterno.

* The lamps with glossy finishes (gold and copper) are not suitable for outdoor use.

Pina ^{PRO}

Pina è una lampada da tavolo a batteria, portatile e ricaricabile. Sulla base è presente un controllo "touch", che permette l'accensione, la regolazione dell'intensità luminosa e la selezione della temperatura di colore della luce. Grazie a un alto indice di protezione, la lampada è utilizzabile anche all'esterno (ad eccezione dei modelli con finitura a foglia metallica e finitura craquelé). Possiede un sistema di controllo elettronico che monitora e segnala l'autonomia residua della batteria, permettendo di ottimizzare le ricariche ed effettuarle sempre in maniera corretta. È dotata di base di ricarica a contatto; caricabatterie incluso. Pina è personalizzabile con il supporto da terra o con il vassoio in ceramica, acquistabili separatamente (pag. 110 e pag. 114).

Pina is a rechargeable battery-powered cordless table lamp. A "touch" control on the base allows switching on/off, dimming, and selecting the color temperature of the light. It is suitable for both indoor and outdoor use (except leaf finishes and craquelé finishes). An electronic control system monitors the remaining autonomy and ensures a constant luminous flux until the battery runs out. Recharging is therefore optimized and always properly done. The lamp comes with a contact charging base; battery charger included. Pina can be accessorized with a floor stand or a ceramic tray, to be purchased separately (pg. 110 and pg. 114).

TAVOLO / SUPPORTO DA TERRA / VASSOIO IN CERAMICA
TABLE / FLOOR STAND / CERAMIC TRAY



LINK TO VIDEO

Pina table lamp white
→ LD1650B3





Pina table lamp sand → **LD1650S3**
 Bilia tumbler and coffee cup → **BA00118 + BA00801**



Pina table lamp corten → **LD1650R3**
 Cipriani Club 55 - New York City, USA



Pina table lamp
gold color leaf → **LD1650BFO**



Pina table lamp corten +
Ceramic tray sand - light blue
→ **LD1650R3 + LD065203**

Pina^{PRO}

Tavolo Table

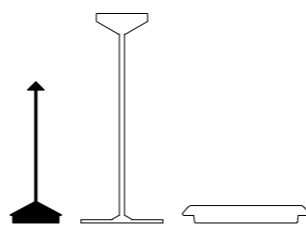

Dati tecnici Technical data

LED TOUCH DIMMER

2200-2700-3000 K | CRI>80
178-204-206 lm | 2,2 W | IP54
50-60 Hz | 5 V max 1A



Corpo in pressofusione di alluminio verniciato
Painted die-cast aluminum body

Schermo diffusore in policarbonato
Polycarbonate diffuser

Adatta all'uso esterno (lampada IP54) e interno (lampada su base di ricarica IP20)
Suitable for outdoor (lamp IP54) and indoor use (lamp on charging base IP20)

Durata di circa 12 h alla massima potenza
Battery lasts about 12 h at full power

Tempo di ricarica a 1A: 6/7 h
Charging time at 1A: 6/7 h

Pacco batteria al litio ricaricabile e sostituibile
Rechargeable and replaceable lithium battery pack

Avvertenze Remarks

Le lampade con finitura in foglia (oro, argento, rame) e con finitura craquelé non sono adatte per uso esterno.
The lamps with leaf finishes (gold, silver, copper) and craquelé finishes are not suitable for outdoor use.

Per effetto della natura manuale della tecnica adottata nella lavorazione con foglia metallica, l'aspetto finale della finitura delle lampade può risultare differente. Eventuali difformità attestano il pregio e l'unicità di ciascuna lampada e non vanno considerate come imperfezioni.
Due to the manual nature of the technique adopted in the application of the metal foil, the final appearance of the lamps' finishing can be different. Any apparent imperfections attest to the quality and exclusivity of each lamp and should not be considered as imperfections.

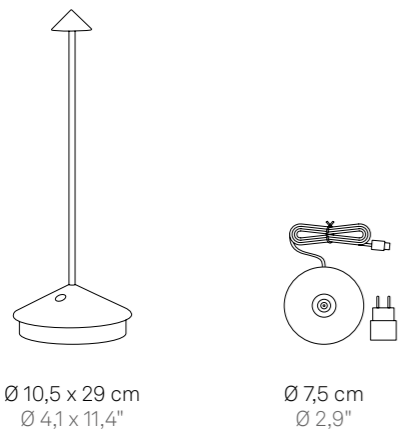

Ø 10,5 x 29 cm
Ø 4,1 x 11,4"

Ø 7,5 cm
Ø 2,9"

Componenti inclusi Components included

Base di ricarica a contatto
Contact charging base
Caricabatterie / Charger
100-240 V | USB-A

Finiture Finishes



LD1650B3
Bianco / White
RAL 9003

LD1650R3
Corten

LD1650N3
Grigio scuro
Dark gray

LD1650D3
Nero / Black
RAL 9004

LD1650S3
Sabbia / Sand



LD1650BFO *
Foglia color oro
Gold color leaf
RAL 9003

LD1650BFA *
Foglia color argento
Silver color leaf
RAL 9003

LD1650RFR *
Foglia color rame
Copper color leaf
RAL 9003

LD1650DFO *
Nero - Foglia color oro
craquelé
Black - Gold color leaf
RAL 9004

* Le lampade con finitura in foglia (oro, argento, rame) e con finitura craquelé non sono adatte per uso esterno.
* The lamps with leaf finishes (gold, silver, copper) and craquelé finishes are not suitable for outdoor use.

Pina^{PRO}**Supporto da terra**
Floor stand

Supporto che trasforma la lampada da tavolo Pina in lampada con picchetto o lampada da terra. L'estremità inferiore del supporto si può montare secondo tre diverse configurazioni: solo con base; solo con picchetto; con picchetto e base, per aumentare la stabilità del supporto. La lampada Pina si alloggia esattamente nella parte superiore del supporto, senza agganciarsi, e può essere agilmente rimossa. Questo supporto non assolve la funzione di ricarica.

A floor stand that turns Pina into a floor lamp or a lamp with peg. The lower end of the stand can be mounted in three different configurations: with the base only, with the peg only, with both peg and base, to increase the stability of the stand. Pina lamp fits exactly in the upper part of the stand, without hooking for easy removal. The floor stand does not charge the lamp.



Pina table lamp sand + Pina floor stand sand
→ LD1650S3 + LD0651S3

Dati tecnici

Technical data

Corpo in alluminio verniciato
Painted aluminum body

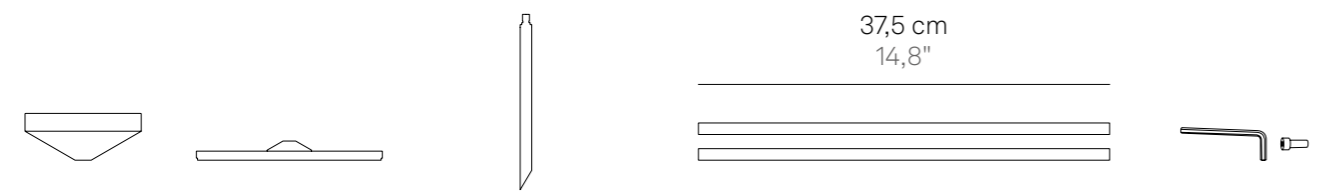
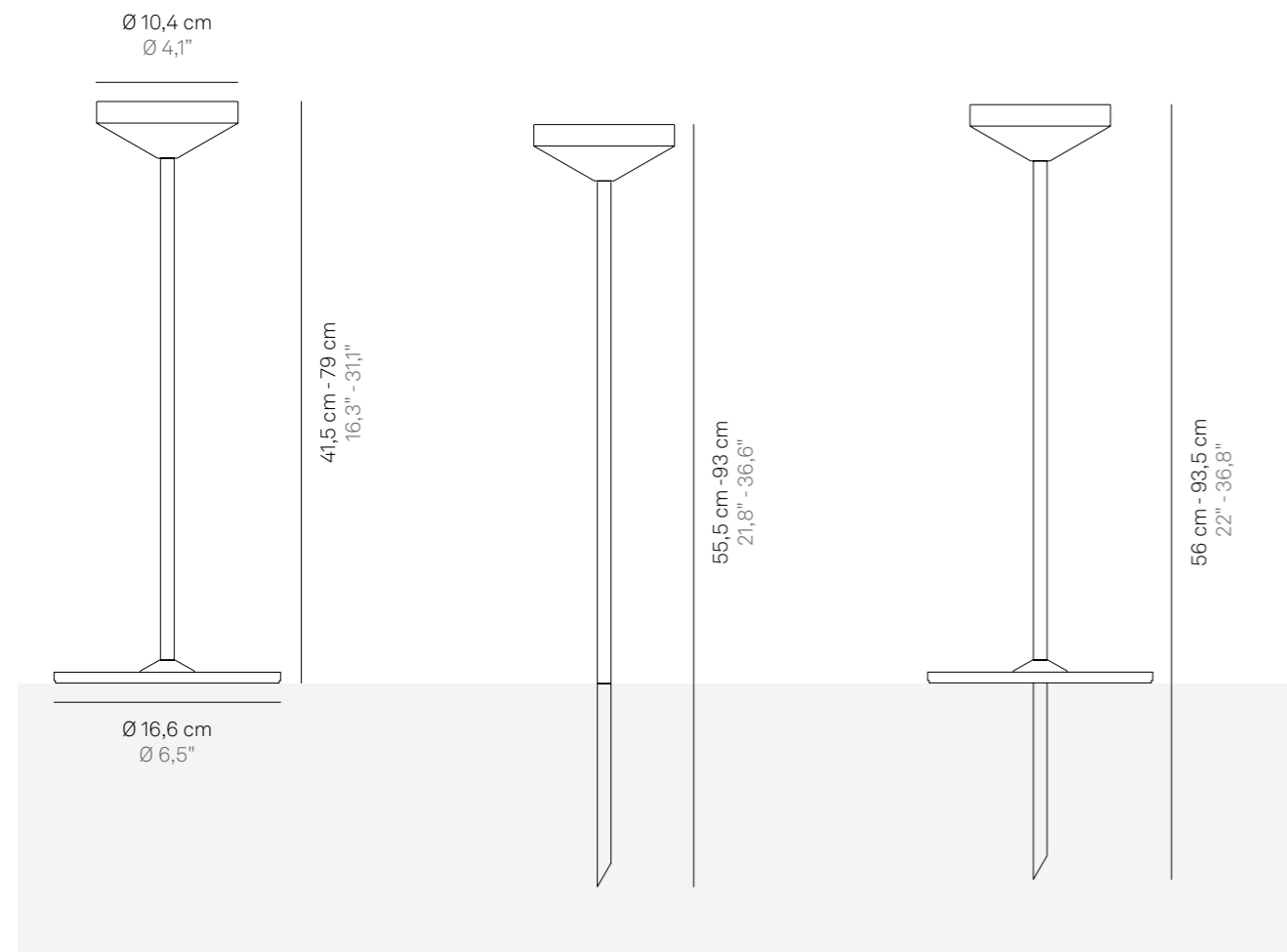

Componenti inclusi

Components included

Base d'appoggio per lampada
Housing for lamp

Base / Base

Picchetto / Peg

Stelo (2 pz.) / Stem (2 pcs.)

Kit di assemblaggio / Assembling kit



Pina table lamp white + Floor stand white
→ **LD1650B3** + **LD0651B3**

Finiture

Finishes



LD0651B3
Bianco
White
RAL 9003



LD0651R3
Corten



LD0651N3
Grigio
scuro
Dark gray



LD0651D3
Nero
Black
RAL 9004



LD0651S3
Sabbia
Sand

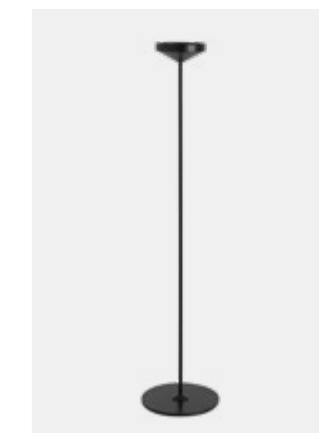

Pina^{PRO}

Vassoio in ceramica Ceramic tray



Dati tecnici Technical data

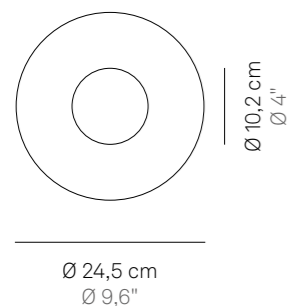

Vassoio in ceramica nella cui parte centrale concava, appositamente sagomata, si può alloggiare la lampada da tavolo Pina.

La stretta collaborazione con un'antica fabbrica di Civita Castellana - borgo viterbese dove l'arte della ceramica è attestata fin dal X secolo a.C. - consente a Zafferano di avvalersi di una produzione esclusiva di manufatti "Made in Italy", decorati a mano su disegno proprio.

Ceramic tray with a concave center that houses the base of Pina. The close partnership with a historic factory in Civita Castellana - a village near Rome, where the art of ceramics has been practiced since the 10th century BC - allows Zafferano to rely on the exclusive production of made in Italy artifacts, which are hand-painted according to Zafferano design.

Finiture Finishes



LD065201
Bianco - Nero
White - Black



LD065202
Blu notte - blu
Navy blue - blue



LD065203
Sabbia - Azzurro
Sand - Light blue



Pina table lamp dark gray +
Ceramic tray white - black
→ **LD1650N3 + LD065201**
Petoni tumbler black → **PT00102**

Swap ^{PRO}

Design Studio Kairos and Federico de Majo

Swap è una collezione di lampade a batteria, portatili e ricaricabili, disponibile nel modello da tavolo in due varianti.

Nella parte superiore della testa è presente un controllo “touch”, che permette l'accensione, la dimmerazione a 4 step e la selezione della temperatura di colore della luce. Grazie all'indice di protezione IP65, la lampada è utilizzabile anche all'esterno. Possiede un sistema di controllo elettronico che monitora e segnala l'autonomia residua della batteria, permettendo di ottimizzare le ricariche ed effettuarle sempre in maniera corretta. È dotata di base di ricarica a contatto. Swap è personalizzabile con paralumi in vetro, ceramica o tessuto, acquistabili separatamente (pag. 128-133).

Swap is a collection of rechargeable battery-powered cordless luminaires, available in the table model in two variants. On the head, a touch control allows you to turn it on/off, dim (4-step: 100%, 60%, 30%, 6%) and select the color temperature of the light. It is suitable for both indoor and outdoor use. An electronic control system monitors the remaining autonomy and ensures a constant luminous flux until the battery runs out. Recharging is therefore optimized and always properly done. All models are equipped with contact charging base. Swap can be customised with glass, ceramic or fabric lampshades, which can be purchased separately (pg. 128-133).



LINK TO VIDEO

TAVOLO / MINI TAVOLO / ACCESSORI
TABLE / MINI TABLE / ACCESSORIES

Swap table lamp white
→ LD1030B3





Swap table lamp
matte titanium → **LD2130T3**



Swap table lamp white
+ glass lampshade blue
→ **LD1030B3 + LD102004**



Swap mini table lamp
Capri blue → **LD1011K3**



Swap mini table lamp corten
+ ceramic lampshade sand-light blue
→ **LD1031R3 + LD101103**

Swap ^{PRO}

Tavolo Table

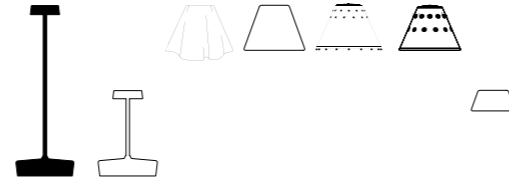

Dati tecnici

Technical data

LED TOUCH DIMMER

2200-2700-3000 K | CRI>90
141-168-192 lm | 2 W | IP65
5 V max.2A



Corpo in pressofusione di alluminio verniciato
Painted die-cast aluminum body

Schermo diffusore in policarbonato satinato
Satin polycarbonate diffuser

Adatta all'uso esterno (lampada IP65) e interno
(lampada su base di ricarica IP20)
Suitable for outdoor (lamp IP65) and indoor use
(lamp on charging base IP20)

Durata di circa 13 h alla massima potenza
Battery lasts about 13 h at full power

Tempo di ricarica a 2A: 3 h
Charging time at 2A: 3 h

Pacco batteria al litio ricaricabile e sostituibile
Rechargeable and replaceable lithium battery pack

Avvertenze

Remarks

La testa delle lampade con finitura oro opaco, bronzo opaco e titanio opaco, è predisposta al fissaggio magnetico delle cover.

Matte gold, matte bronze and matte titanium finish lamp heads are prepared for magnetic cover attachment.

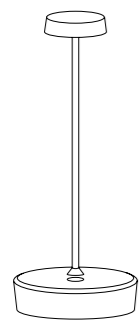

Ø 10 x 29 cm
Ø 3,9 x 11,4"

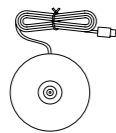

Ø 7,5 cm
Ø 2,9"

Accessori inclusi

Accessories included

Base di ricarica a contatto
Contact charging base

Accessori non inclusi

Accessories not included

Caricatore / Charger → **LD0300UC** (pg. 248)
5 V max 2,1 A | 100-240V | USB-A

Finiture

Finishes



LD1030B3
Bianco / White
RAL 9002



LD1030R3
Corten



LD1030N3
Nero / Black
RAL 9005



LD2130O3
Oro opaco / Matte gold
MGO



LD2130W3
Bronzo opaco / Matte bronze
MBR



LD2130T3
Titanio opaco / Matte titanium
MTI

La testa delle lampade con finitura oro opaco, bronzo opaco e titanio opaco, è predisposta al fissaggio magnetico delle cover.
Matte gold, matte bronze and matte titanium finish lamp heads are prepared for magnetic cover attachment.

Swap ^{PRO}

Mini tavolo Mini table

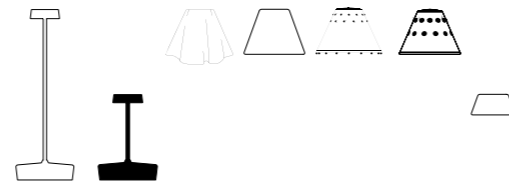

Dati tecnici

Technical data

LED TOUCH DIMMER

2700 K | CRI>90

267 lm | 2 W | IP65

5 V max 1A



Corpo in pressofusione di alluminio verniciato
Painted die-cast aluminum body

Schermo diffusore in policarbonato
Polycarbonate diffuser

Adatta all'uso esterno (lampada IP65) e interno
(lampada su base di ricarica IP20)
Suitable for outdoor (lamp IP65) and indoor use
(lamp on charging base IP20)

Durata di circa 13 h alla massima potenza
Battery lasts about 13 h at full power

Tempo di ricarica a 1A: 6 h
Charging time at 1A: 6 h

Pacco batteria al litio ricaricabile e sostituibile
Rechargeable and replaceable lithium battery pack

Finiture

Finishes



LD1011B3

Bianco / White

RAL 9002



LD1011K3

Blu Capri / Capri blue

RAL 5019



LD1011L3

Lilla / Lilac

RAL 4005



LD1011V3

Verde mela / Apple green

RAL 6018



LD1011Z3

Arancio / Orange

RAL 2008

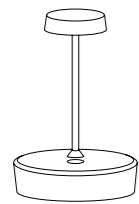

Ø 10 x 14,8 cm
Ø 3,9 x 5,8"

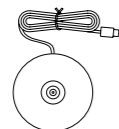

Ø 7,5 cm
Ø 2,9"

Componenti inclusi

Components included

Base di ricarica a contatto
Contact charging base

Accessori non inclusi

Accessories not included

Caricatore / Charger → **LD0490UA** (pg. 217)
5 V max1 A | 100-240V | USB-A

Swap ^{PRO}

Mini tavolo Mini table

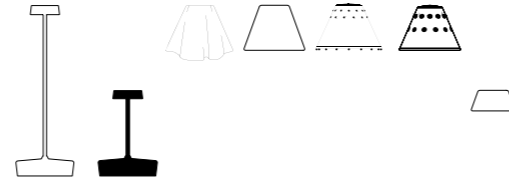

Dati tecnici

Technical data

LED TOUCH DIMMER

2200-2700-3000 K | CRI>90
141-168-192 lm | 2 W | IP65
5 V max.2A



Corpo in pressofusione di alluminio verniciato
Painted die-cast aluminum body

Schermo diffusore in policarbonato satinato
Satin polycarbonate diffuser

Adatta all'uso esterno (lampada IP65) e interno (lampada su base di ricarica IP20)
Suitable for outdoor (lamp IP65) and indoor use (lamp on charging base IP20)

Durata di circa 13 h alla massima potenza
Battery lasts about 13 h at full power

Tempo di ricarica a 2A: 3 h
Charging time at 2A: 3 h

Pacco batteria al litio ricaricabile e sostituibile
Rechargeable and replaceable lithium battery pack

Avvertenze

Remarks

La testa delle lampade con finitura oro opaco, bronzo opaco e titanio opaco, è predisposta al fissaggio magnetico delle cover.
Matte gold, matte bronze and matte titanium finish lamp heads are prepared for magnetic cover attachment.

Matte gold, matte bronze and matte titanium finish lamp heads are prepared for magnetic cover attachment.

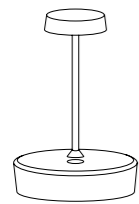

Ø 10 x 14,8 cm
Ø 3,9 x 5,8"

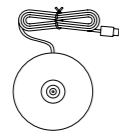

Ø 7,5 cm
Ø 2,9"

Componenti inclusi

Components included

Base di ricarica a contatto
Contact charging base

Accessori non inclusi

Accessories not included

Caricatore / Charger → **LD0300UC** (pg. 217)
5 V max 2,1 A | 100-240V | USB-A

Finiture

Finishes



LD1031R3

Corten



LD1131N3

Nero / Black
RAL 9005



LD1031O3 *

Oro lucido / Glossy gold
Galvanic finish



LD2131O3

Oro opaco / Matte gold
MGO



LD2131W3

Bronzo opaco / Matte bronze
MBR



LD2131T3

Titanio opaco / Matte titanium
MTI

* La lampada con finitura oro lucido non è adatta per uso esterno.

* The lamp with glossy gold finish is not suitable for outdoor use.

La testa delle lampade con finitura oro opaco, bronzo opaco e titanio opaco, è predisposta al fissaggio magnetico delle cover.
Matte gold, matte bronze and matte titanium finish lamp heads are prepared for magnetic cover attachment.

Swap^{PRO}

Paralume in tessuto

Fabric lampshade



Dati tecnici

Technical data



Componenti inclusi
Components included

Magnete e dima
Magnet and cut-out

Video tutorial: montaggio paralume
Tutorial video: installation of the lampshade



Avvertenze
Remarks

Paralume in tessuto ignifugo su richiesta.
Fire-retardant fabric lampshade on request.

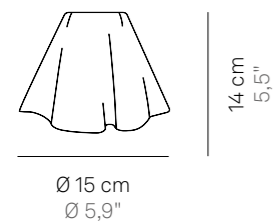

Paralume morbido in tessuto elastico, lavabile e ingualcibile, con dischetto in policarbonato e orlo sopraffilato, che si fissa alla testa di Swap tramite un magnete.

A soft lampshade made of elastic fabric, which is washable and crease-resistant, with a polycarbonate disc and a zig-zag edging, that is fixed to the head of the lamp with a magnet.

Finiture
Finishes



LD102000
Bianco / White



LD102005
Nero / Black



Swap table lamp black + fabric lampshade black
→ LD1030N3 + LD102005

Swap^{PRO}

Paralume in vetro

Glass lampshade



Dati tecnici

Technical data



Componenti inclusi
Components included

Magnete e dima
Magnet and cut-out

Video tutorial: montaggio paralume
Tutorial video: installation of the lampshade

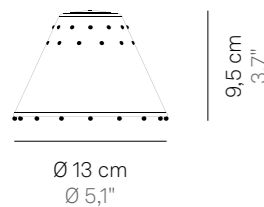
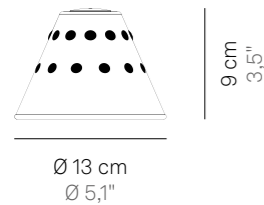

Paralume in vetro borosilicato soffiato e lavorato a mano con decorazioni a rilievo, che si fissa alla testa di Swap tramite un magnete.

A handcrafted, blown borosilicate glass lampshade, with relief decorations, that is fixed to the head of the lamp with a magnet.

Finiture

Finishes



LD102001
Bianco / White



LD102002
Nero / Black



LD102003
Ambra / Amber



LD102004
Blu / Blue



LD102011
Bianco / White



LD102012
Nero / Black



LD102013
Ambra / Amber



LD102014
Blu / Blue



Swap^{PRO}

Paralume in ceramica Ceramic lampshade



Dati tecnici

Technical data



Componenti inclusi Components included

Magnete e dima
Magnet and cut-out

Video tutorial: montaggio paralume
Tutorial video: installation of the lampshade

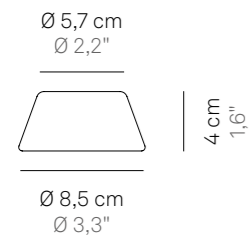
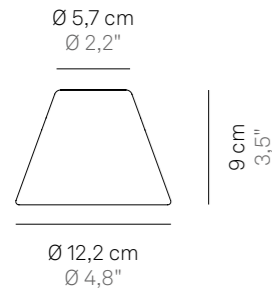

Paralume in ceramica che si fissa alla testa di Swap tramite un magnete.

La stretta collaborazione con un'antica fabbrica di Civita Castellana - borgo viterbese dove l'arte della ceramica è attestata fin dal X secolo a.C. – consente a Zafferano di avvalersi di una produzione esclusiva di manufatti "Made in Italy", decorati a mano su disegno proprio o del cliente.

Ceramic lampshade that is fixed to the head of the lamp with a magnet.

The close partnership with a historic factory in Civita Castellana - a village near Rome, where the art of ceramics has been practiced since the 10th century BC - allows Zafferano to rely on the exclusive production of made in Italy artifacts, which are hand-painted according to Zafferano design; customization available.

Finiture Finishes



LD102101
Bianco - Nero
White - Black



LD102103
Sabbia - Azzurro
Sand - Light blue

Finiture Finishes



LD101101
Bianco - Nero
White - Black



LD101102
Blu notte - Blu
Navy blue - Blue



LD101103
Sabbia - Azzurro
Sand - Light blue



LD101104
Pesci azzurri
Light blue fish



LD101105
Pois verdi
Green dots



LD101106
Pois arancio
Orange dots



LD101107
Pois azzurri
Light blue dots



LD101108
Pois rosso
Red dots



LD101109
Pois neri
Black dots

Ofelia ^{PRO}

Ofelia è una collezione di lampade a batteria, portatili e ricaricabili, disponibile nel modello da tavolo in due varianti.

Nella parte superiore della testa è presente un controllo "touch", che permette l'accensione, la regolazione dell'intensità luminosa e la selezione della temperatura di colore della luce. Ofelia possiede inoltre la funzione di memoria dell'impostazione di dimmerazione: di conseguenza, ad ogni accensione, l'intensità luminosa corrisponderà a quella precedentemente impostata. Grazie a un alto indice di protezione, la lampada è utilizzabile anche all'esterno. È dotata di base di ricarica a contatto.

Ofelia is a collection of rechargeable battery-powered cordless luminaires, available in the table model in two variants. A "touch" control on the head allows switching on/off, dimming, and selecting the color temperature of the light. Ofelia is equipped with the dimmer memory function, which adjusts the light intensity and memorizes the dimmer steps; consequently, every time it is switched on, the light intensity will correspond to that previously set. It is suitable for both indoor and outdoor use. The lamp comes with a contact charging base.



Ofelia table lamp sage green
→ LD1870G3





Ofelia^{PRO}

Tavolo Table

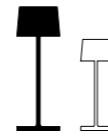

Dati tecnici

Technical data

LED TOUCH DIMMER

2200-2700-3000 K | CRI>80
231-244-252 lm | 2,2 W | IP65
50-60 Hz | 5 V max 1A



Corpo in pressofusione di alluminio verniciato
Painted die-cast aluminum body

Schermo diffusore in policarbonato prismatico
Prismatic polycarbonate diffuser

Adatta all'uso esterno (lampada IP65) e interno
(lampada su base di ricarica IP20)
Suitable for outdoor (lamp IP65) and indoor use
(lamp on charging base IP20)

Durata di circa 9 h alla massima potenza
Battery lasts about 9 h at full power

Tempo di ricarica a 1A: 6 h
Charging time at 1A: 6 h

Pacco batteria al litio ricaricabile e sostituibile
Rechargeable and replaceable lithium battery pack

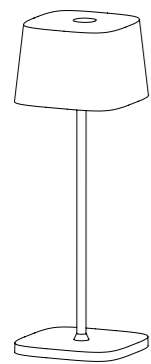

10 x 10 x 29 cm
3,9 x 3,9 x 11,4"

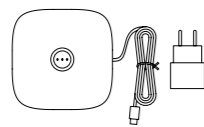

11,6 x 11,6 cm
4,5 x 4,5"

Componenti inclusi

Components included

Base di ricarica a contatto
Contact charging base

Caricabatterie / Charger
100-240 V | USB-A

Finiture Finishes



LD1870B3
Bianco / White
RAL 9016

LD1870R3
Corten

LD1870N3
Grigio scuro
Dark gray
RAL 7024

LD1870S3
Sabbia / Sand
RAL 1014

LD1870G3
Salvia / Sage green
Pantone 5635 U



Ofelia table lamp
sand → **LD1870S3**
Ristorante Oltre
Leporano, Italy
Photo Giuseppe Musolino

Ofelia ^{PRO}

Micro tavolo Micro table

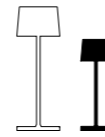

Dati tecnici

Technical data

LED TOUCH DIMMER

2200-2700-3000 K | CRI>80
183-195-216 lm | 2,2 W | IP65
5 V max 1A



Corpo in pressofusione di alluminio verniciato
Painted die-cast aluminum body

Schermo diffusore in policarbonato prismatico
Prismatic polycarbonate diffuser

Adatta all'uso esterno (lampada IP65) e interno
(lampada su base di ricarica IP20)
Suitable for outdoor (lamp IP65) and indoor use
(lamp on charging base IP20)

Durata di circa 9 h alla massima potenza
Battery lasts about 9 h at full power

Tempo di ricarica a 1A: 4,5 h
Charging time at 1A: 4,5 h

Pacco batteria al litio ricaricabile e sostituibile
Rechargeable and replaceable lithium battery pack

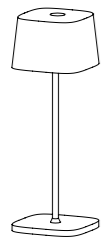

6,7 x 6,7 x 20 cm
2,6 x 2,6 x 7,9"

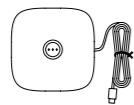

7,1 x 7,1 cm
2,8 x 2,8"

Componenti inclusi

Components included

Base di ricarica a contatto
Contact charging base

Accessori non inclusi

Accessories not included

Caricatore / Charger → **LD0490UA** (pg. 217)
5 V max 1A | 100-240V | USB-A

Finiture

Finishes



LD1880B3
Bianco / White
RAL 9016



LD1880R3
Corten



LD1880N3
Grigio scuro
Dark gray
RAL 7024



LD1880S3
Sabbia / Sand
RAL 1014



LD1880G3
Salvia / Sage green
Pantone 5635 U



Olivia ^{PRO}

Olivia è una collezione di lampade a batteria, portatili e ricaricabili, disponibile nel modello da tavolo in tre varianti.

Nella parte superiore della testa è presente un controllo "touch", che permette l'accensione, la regolazione dell'intensità luminosa e la selezione della temperatura di colore della luce. Olivia possiede inoltre la funzione di memoria dell'impostazione di dimmerazione: di conseguenza, ad ogni accensione, l'intensità luminosa corrisponderà a quella precedentemente impostata.

Grazie a un alto indice di protezione, la lampada è utilizzabile anche all'esterno (ad eccezione dei modelli con finitura a foglia metallica).

È dotata di base di ricarica a contatto.

Olivia is a collection of rechargeable battery-powered cordless luminaires, available in the table model in three variants. A "touch" control on the head allows switching on/off, dimming, and selecting the color temperature of the light. Olivia is equipped with the dimmer memory function, which adjusts the light intensity and memorizes the dimmer steps; consequently, every time it is switched on, the light intensity will correspond to that previously set. It is suitable for both indoor and outdoor use (except leaf finishes). The lamp comes with a contact charging base.

TAVOLO / MINI TAVOLO / MICRO TAVOLO
TABLE / MINI TABLE / MICRO TABLE



LINK TO VIDEO



Olivia table lamp
corten → **LD1850R3**
A Cavaliça
Évora, Portugal
Photo Francisco Nogueira



Olivia mini table lamp orange → **LD0860Z3**
Olivia mini table lamp Capri blue → **LD0860K3**
Olivia mini table lamp apple green → **LD0860V3**

Olivia ^{PRO}

Tavolo Table

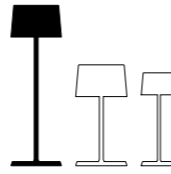

Dati tecnici

Technical data

LED TOUCH DIMMER

2700-3000 K | CRI>80
245-262 lm | 2,2 W | IP65
50-60 Hz | 5 V max 1A



Corpo in pressofusione di alluminio verniciato
Painted die-cast aluminum body

Schermo diffusore in policarbonato prismatico
Prismatic polycarbonate diffuser

Adatta all'uso esterno (lampada IP65) e interno
(lampada su base di ricarica IP20)
Suitable for outdoor (lamp IP65) and indoor use
(lamp on charging base IP20)

Durata di circa 9 h alla massima potenza
Battery lasts about 9 h at full power

Tempo di ricarica a 1A: 6 h
Charging time at 1A: 6 h

Pacco batteria al litio ricaricabile e sostituibile
Rechargeable and replaceable lithium battery pack

Avvertenze

Remarks

Le lampade con finitura in foglia (oro, argento, rame)
non sono adatte per uso esterno.
The lamps with leaf finishes (gold, silver and copper)
are not suitable for outdoor use.

Per effetto della natura manuale della tecnica
adottata nella lavorazione con foglia metallica,
l'aspetto finale della finitura delle lampade può
risultare differente. Eventuali difformità attestano il
pregio e l'unicità di ciascuna lampada e non vanno
considerate come imperfezioni.

Due to the manual nature of the technique adopted
in the application of the metal foil, the final
appearance of the lamps' finishing can be different.
Any apparent imperfections attest to the quality
and exclusivity of each lamp and should not be
considered as imperfections.

Le lampade con finitura corten e sabbia sono dotate
della funzione di selezione della temperatura di
colore della luce tra 2200, 2700 e 3000 K.
The lamps with corten and sand finishes are
equipped with a light color temperature selection
function 2200, 2700 or 3000 K.

Finiture Finishes



LD0850B3
Bianco / White
RAL 9016



LD1850R3
Corten



LD0850N3
Grigio scuro / Dark gray
RAL 7012



LD1850S3
Sabbia / Sand
RAL 1014



LD0850BFO *
Foglia color oro
Gold color leaf



LD0850BFA *
Foglia color argento
Silver color leaf



LD0850RFR *
Foglia color rame
Copper color leaf

* Le lampade con finitura in foglia (oro, argento, rame) non sono adatte per uso esterno.

* The lamps with leaf finishes (gold, silver, copper) are not suitable for outdoor use.

Le lampade con finitura corten e sabbia sono dotate della funzione di selezione della temperatura di colore della luce tra 2200, 2700 e 3000 K.
The lamps with corten and sand finishes are equipped with a light color temperature selection function 2200, 2700 or 3000 K.

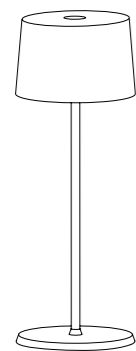

Ø 11 x 35 cm
Ø 4,3 x 13,8"

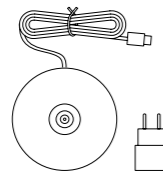

Ø 11,6 cm
Ø 4,5"

Componenti inclusi Components included

Base di ricarica a contatto
Contact charging base

Caricabatterie / Charger
100-240 V | USB-A

Olivia ^{PRO}

Mini tavolo Mini table

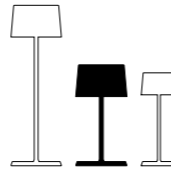

Dati tecnici

Technical data

LED TOUCH DIMMER

2700-3000 K | CRI>80
245-262 lm | 2,2 W | IP65
50-60 Hz | 5 V max 1A



Corpo in pressofusione di alluminio verniciato
Painted die-cast aluminum body

Schermo diffusore in policarbonato prismatico
Prismatic polycarbonate diffuser

Adatta all'uso esterno (lampada IP65) e interno
(lampada su base di ricarica IP20)
Suitable for outdoor (lamp IP65) and indoor use
(lamp on charging base IP20)

Durata di circa 9 h alla massima potenza
Battery lasts about 9 h at full power

Tempo di ricarica a 1A: 6 h
Charging time at 1A: 6 h

Pacco batteria al litio ricaricabile e sostituibile
Rechargeable and replaceable lithium battery pack

Avvertenze

Remarks

Le lampade con finitura bianco, corten e grigio scuro sono dotate della funzione di selezione della temperatura di colore della luce tra 2200, 2700 e 3000 K.

The lamps with white, corten and dark gray finish are equipped with a light color temperature selection function 2200 K, 2700 K or 3000 K.

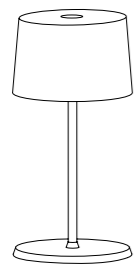

Ø 11 x 22 cm
Ø 4,3 x 8,7"

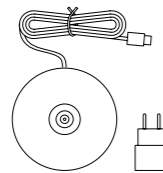

Ø 11,6 cm
Ø 4,5"

Componenti inclusi

Components included

Base di ricarica a contatto
Contact charging base

Caricabatterie / Charger
100-240 V | USB-A

Finiture

Finishes



LD1860B3 *

Bianco / White
RAL 9016



LD1860R3 *

Corten



LD1860N3 *

Grigio scuro / Dark gray
RAL 7012



LD0860K3

Blu Capri / Capri blue
RAL 5019



LD0860L3

Lilla / Lilac
RAL 4005



LD0860V3

Verde mela / Apple green
RAL 6018



LD0860Z3

Arancio / Orange
RAL 2008

* Le lampade con finitura bianco, corten e grigio scuro sono dotate della funzione di selezione della temperatura di colore della luce tra 2200, 2700 e 3000 K.

* The lamps with white, corten and dark gray finish are equipped with a light color temperature selection function 2200, 2700 or 3000 K.

Olivia ^{PRO}

Micro tavolo Micro table

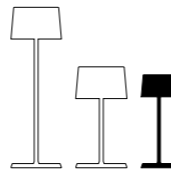

Dati tecnici

Technical data

LED TOUCH DIMMER

2200-2700-3000 K | CRI>80
183-187-225 lm | 2,2 W | IP65
5 V max 1A



Corpo in pressofusione di alluminio verniciato
Painted die-cast aluminum body

Schermo diffusore in policarbonato prismatico
Prismatic polycarbonate diffuser

Adatta all'uso esterno (lampada IP65) e interno
(lampada su base di ricarica IP20)
Suitable for outdoor (lamp IP65) and indoor use
(lamp on charging base IP20)

Durata di circa 9 h alla massima potenza
Battery lasts about 9 h at full power

Tempo di ricarica a 1A: 4,5 h
Charging time at 1A: 4,5 h

Pacco batteria al litio ricaricabile e sostituibile
Rechargeable and replaceable lithium battery pack

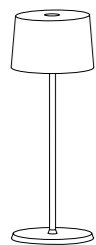

Ø 7,5 x 20 cm
Ø 3 x 7,9"



Ø 7,9 cm
Ø 3,1"

Componenti inclusi

Components included

Base di ricarica a contatto
Contact charging base

Accessori non inclusi

Accessories not included

Caricatore / Charger → **LD0490UA** (pg. 217)
5 V max 1A | 100-240V | USB-A

Finiture

Finishes



LD1840B3
Bianco / White
RAL 9016



LD1840R3
Corten



LD1840N3
Grigio scuro / Dark gray
RAL 7012



LD1840S3
Sabbia / Sand
RAL 1014



Olivia table lamp dark gray → **LD1850**
Olivia mini table lamp dark gray → **LD0860N3**
Olivia micro table lamp dark gray → **LD1840N3**

Push-up^{PRO}

Push-up è una lampada da tavolo a batteria, portatile e ricaricabile. Premendo la parte superiore della lampada, questa si solleva e contemporaneamente si accende; premendo nuovamente fino alla chiusura, la lampada si spegne. Sotto la base è presente un controllo "touch", che – quando la parte superiore della lampada è sollevata – permette lo spegnimento, la regolazione dell'intensità luminosa e la selezione della temperatura di colore della. Grazie a un alto indice di protezione, la lampada è utilizzabile anche all'esterno. Possiede un sistema di controllo elettronico che monitora e segnala l'autonomia residua della batteria, permettendo di ottimizzare le ricariche ed effettuarle sempre in maniera corretta. È dotata di base di ricarica a contatto. Caricabatterie non incluso.

Push-up is a rechargeable battery-powered cordless table lamp. Pushing the lid down, lifts the diffuser up and turns the light on; pushing the lid back down, closes the lamp while turning the light off. A "touch" control hidden under the base allows switching on/off, dimming, and selecting the color temperature of the light. It is suitable for both indoor and outdoor use. An electronic control system monitors the remaining autonomy and ensures a constant luminous flux until the battery runs out. Recharging is therefore optimized and always properly done. The lamp comes with a contact charging base; the battery charger is not included.

Push-up table lamp
white → **LD1050B3**



Push-up^{PRO}

Tavolo Table



Dati tecnici

Technical data

LED TOUCH DIMMER

2200-2700-3000 K | CRI>80
207-235-248 lm | 2,2 W | IP54
5 V max 1A

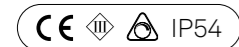

Corpo in pressofusione di alluminio verniciato
Painted die-cast aluminum body

Schermo diffusore in policarbonato
Polycarbonate diffuser

Adatta all'uso esterno (lampada IP54) e interno
(lampada su base di ricarica IP20)
Suitable for outdoor (lamp IP54) and indoor use
(lamp on charging base IP20)

Durata di circa 11/12 h alla massima potenza
Battery lasts about 11/12 h at full power

Tempo di ricarica a 1A: 5/6 h
Charging time at 1A: 5/6 h

Pacco batteria al litio ricaricabile e sostituibile
Rechargeable and replaceable lithium battery pack

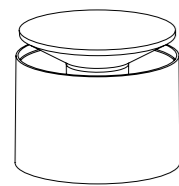

Ø 12 x 8,3-10 cm
Ø 4,7 x 3,3-3,9"

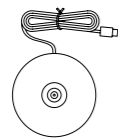

Ø 10 cm
Ø 3,9"

Componenti inclusi

Components included

Base di ricarica a contatto
Contact charging base

Accessori non inclusi

Accessories not included

Caricatore / Charger → **LD0490UA** (pg. 217)
5 V max 1A | 100-240V | USB-A

Finiture Finishes



LD1050B3

Bianco / White
RAL 9003



LD1050R3

Corten



LD1050N3

Grigio scuro / Dark gray



LD1050S3

Sabbia / Sand



Push-up table lamp dark gray → **LD1050N3**
Push-up table lamp corten → **LD1050R3**

Olimpia ^{PRO}

Design Federico de Majo

Olimpia è una lampada da tavolo a batteria, portatile e ricaricabile, con diffusore sferico in vetro opale satinato opaco soffiato a bocca. Sulla base è presente un controllo "touch", che permette l'accensione e la regolazione dell'intensità luminosa. Grazie a un alto indice di protezione, la lampada è utilizzabile anche all'esterno (ad eccezione dei modelli con finitura galvanica). È possibile rendere più caldo il colore della luce, sostituendo il filtro già presente sulla sorgente luminosa con quello color ambra (fornito in dotazione). È dotata di base di ricarica a contatto. Caricabatterie incluso.

Olimpia is a battery-operated, portable and rechargeable table lamp with a spherical, mouth-blown satin-finish opal glass sphere. A "touch" control on the base allows switching on/off and dimming. It is suitable for both indoor and outdoor use (except galvanic finishes). The color temperature of the light can be changed to warmer by swapping the filter onboard with the amber one (included). The lamp comes with a contact charging base; the battery charger is included.

TAVOLO
TABLE



LINK TO VIDEO

Olimpia table lamp copper → **LD0900E3**
Pirolo tumber amber → **PI00104**





Olimpia table lamp dark gray → **LD0900N3**

Olimpia ^{PRO}

Tavolo Table



Dati tecnici

Technical data

LED TOUCH DIMMER

3000 K | CRI>80
268 lm | 2,5 W | IP54
50-60 Hz | 5 V max 1A



Corpo in pressofusione di alluminio verniciato
Painted die-cast aluminum body

Sfera in vetro opale satinato opaco soffiato a bocca
Mouth-blown satin-finish opal glass sphere

Schermo diffusore in policarbonato
Polycarbonate diffuser

Adatta all'uso esterno (lampada IP54) e interno
(lampada su base di ricarica IP20)
Suitable for outdoor (lamp IP54) and indoor use
(lamp on charging base IP20)

Durata di circa 9 h alla massima potenza
Battery lasts about 9 h at full power

Tempo di ricarica a 1A: 9 h
Charging time at 1A: 9 h

Pacco batteria al litio ricaricabile e sostituibile
Rechargeable and replaceable lithium battery pack

Avvertenze

Remarks

Le lampade con finitura lucida (oro, cromo e rame)
non sono adatte per uso esterno.

The lamps with glossy finishes (gold, chrome and
silver) are not suitable for outdoor use.

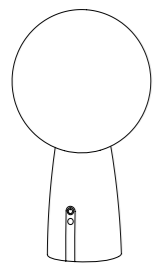

Ø 15 x 26 cm
Ø 5,9" x 10,2"

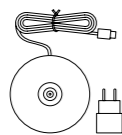

Ø 7,5 cm
Ø 2,9"

Componenti inclusi

Components included

Base di ricarica a contatto
Contact charging base

Caricabatterie / Charger
100-240 V | USB-A

Filtro
Lens

Finiture Finishes



LD0900B3
Bianco / White
RAL 9003



LD0900N3
Grigio scuro / Dark gray



LD090003 *
Oro lucido / Glossy gold
Galvanic finish



LD0900C3 *
Cromo lucido / Glossy chrome
Galvanic finish



LD0900E3 *
Rame lucido / Glossy copper
Galvanic finish

* Le lampade con finitura lucida (oro, cromo e rame) non sono adatte per uso esterno.

* The lamps with glossy finishes (gold, chrome and copper) are not suitable for outdoor use.

Dama PRO

Dama è una lampada da tavolo a batteria, portatile e ricaricabile. Nella parte superiore della testa è presente un controllo "touch", che permette l'accensione, la regolazione dell'intensità luminosa e la selezione della temperatura di colore della luce. Grazie a un alto indice di protezione, la lampada è utilizzabile anche all'esterno. Possiede un sistema di controllo elettronico che monitora e segnala l'autonomia residua della batteria, permettendo di ottimizzare le ricariche ed effettuarle sempre in maniera corretta. È dotata di base di ricarica a contatto. Caricabatterie incluso.

Dama is a rechargeable battery-powered cordless table lamp. A "touch" control on the head allows switching on/off, dimming, and selecting the color temperature of the light. It is suitable for both indoor and outdoor use. An electronic control system monitors the remaining autonomy and ensures a constant luminous flux until the battery runs out. Recharging is therefore optimized and always properly done. The lamp comes with a contact charging base; the battery charger is included.

TAVOLO
TABLE



LINK TO VIDEO

Dama table lamp white
→ LD0610B3



Dama^{PRO}

Tavolo Table



Dati tecnici

Technical data

LED TOUCH DIMMER

2200-2700-3000 K | CRI>80
194-219-221 lm | 2,2 W | IP54
50-60 Hz | 5 V max 1A



Corpo in pressofusione di alluminio verniciato
Painted die-cast aluminum body

Schermo diffusore in policarbonato
Polycarbonate diffuser

Adatta all'uso esterno (lampada IP54) e interno
(lampada su base di ricarica IP20)
Suitable for outdoor (lamp IP54) and indoor use
(lamp on charging base IP20)

Durata di circa 9 h alla massima potenza
Battery lasts about 9 h at full power

Tempo di ricarica a 1A: 6 h
Charging time at 1A: 6 h

Pacco batteria al litio ricaricabile e sostituibile
Rechargeable and replaceable lithium battery pack

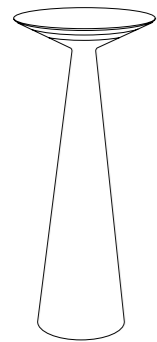

Ø 12,5 x 29 cm
Ø 4,9 x 11,4"

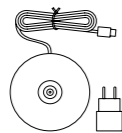

Ø 7,5 cm
Ø 2,9"

Componenti inclusi

Components included

Base di ricarica a contatto
Contact charging base

Caricabatterie / Charger
100-240 V | USB-A

Finiture

Finishes



LD0610B3
Bianco / White
RAL 9003

LD0610N3
Nero opaco / Black
RAL 9004



Dama table lamp white
→ **LD0610B3**
Raionul de Peste
Bucharest, Romania
Photo Sebastian Stan

Home ^{PRO}

Home è una lampada da tavolo a batteria, portatile e ricaricabile. Sulla base è presente un controllo "touch", che permette l'accensione e la regolazione dell'intensità luminosa. Grazie a un alto indice di protezione, la lampada è utilizzabile anche all'esterno. Possiede un sistema di controllo elettronico che monitora e segnala l'autonomia residua della batteria, permettendo di ottimizzare le ricariche ed effettuarle sempre in maniera corretta. È dotata di base di ricarica a contatto. Caricabatterie incluso. Home può diventare una lampada da parete tramite l'apposito accessorio, acquistabile separatamente (pag. 170).

Home is a rechargeable battery-powered cordless table lamp. A "touch" control on the base allows switching on/off and dimming. It is suitable for both indoor and outdoor use. An electronic control system monitors the remaining autonomy and ensures a constant luminous flux until the battery runs out. Recharging is therefore optimized and always properly done. The lamp comes with a contact charging base; the battery charger is included. Home can become a wall lamp thanks its dedicated accessory, to be purchased separately (pg. 170).

TAVOLO / SUPPORTO PARETE
TABLE / WALL LAMP KIT



LINK TO VIDEO

Home table lamp white
→ LD0258B3



Home ^{PRO}

Tavolo Table

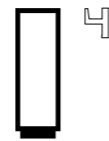

Dati tecnici

Technical data

LED TOUCH DIMMER

3000 K | CRI>80
260 lm | 2,2 W | IP54
50-60 Hz | 5 V max 1A



Corpo in pressofusione di alluminio verniciato
Painted die-cast aluminum body

Schermo diffusore in policarbonato
Polycarbonate diffuser

Adatta all'uso esterno (lampada IP54) e interno
(lampada su base di ricarica IP20)
Suitable for outdoor (lamp IP54) and indoor use
(lamp on charging base IP20)

Durata di circa 12 h alla massima potenza
Battery lasts about 12 h at full power

Tempo di ricarica a 1A: 6/8 h
Charging time at 1A: 6/8 h

Pacco batteria al litio ricaricabile e sostituibile
Rechargeable and replaceable lithium battery pack

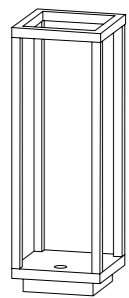

10 x 10 x 29,4 cm
3,9 x 3,9 x 11,6"

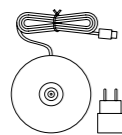

Ø 7,5 cm
Ø 2,9"

Componenti inclusi

Components included

Base di ricarica a contatto
Contact charging base

Caricabatterie / Charger
100-240 V | USB-A

Finiture

Finishes



LD0258B3
Bianco / White
RAL 9003



LD0258R3
Corten



LD0258N3
Grigio scuro / Dark gray



Home table lamp white
→ **LD0258B3**
Photo Digital Snack

Home ^{PRO}

Supporto parete Wall lamp kit



Dati tecnici Technical data

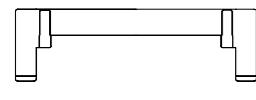

9,7 cm
3,8"

3 cm
1,2"

Finiture Finishes



LD0259B3
Bianco
White
RAL 9003



LD0259R3
Corten



LD0259N3
Grigio scuro
Dark gray

Supporto in pressofusione d'alluminio verniciato
Painted die-cast aluminum element



Supporto che trasforma la lampada da tavolo Home in lampada da parete. La lampada può essere usata nel suo supporto fisso, ma anche rimossa e portata con sé da un ambiente all'altro.

A wall bracket that turns Home into a wall lamp. The lamp can be used in its fixed housing or detached and carried from one place to another.

Home table lamp white
+ Home wall lamp kit white
→ **LD0258B3** + **LD0259B3**

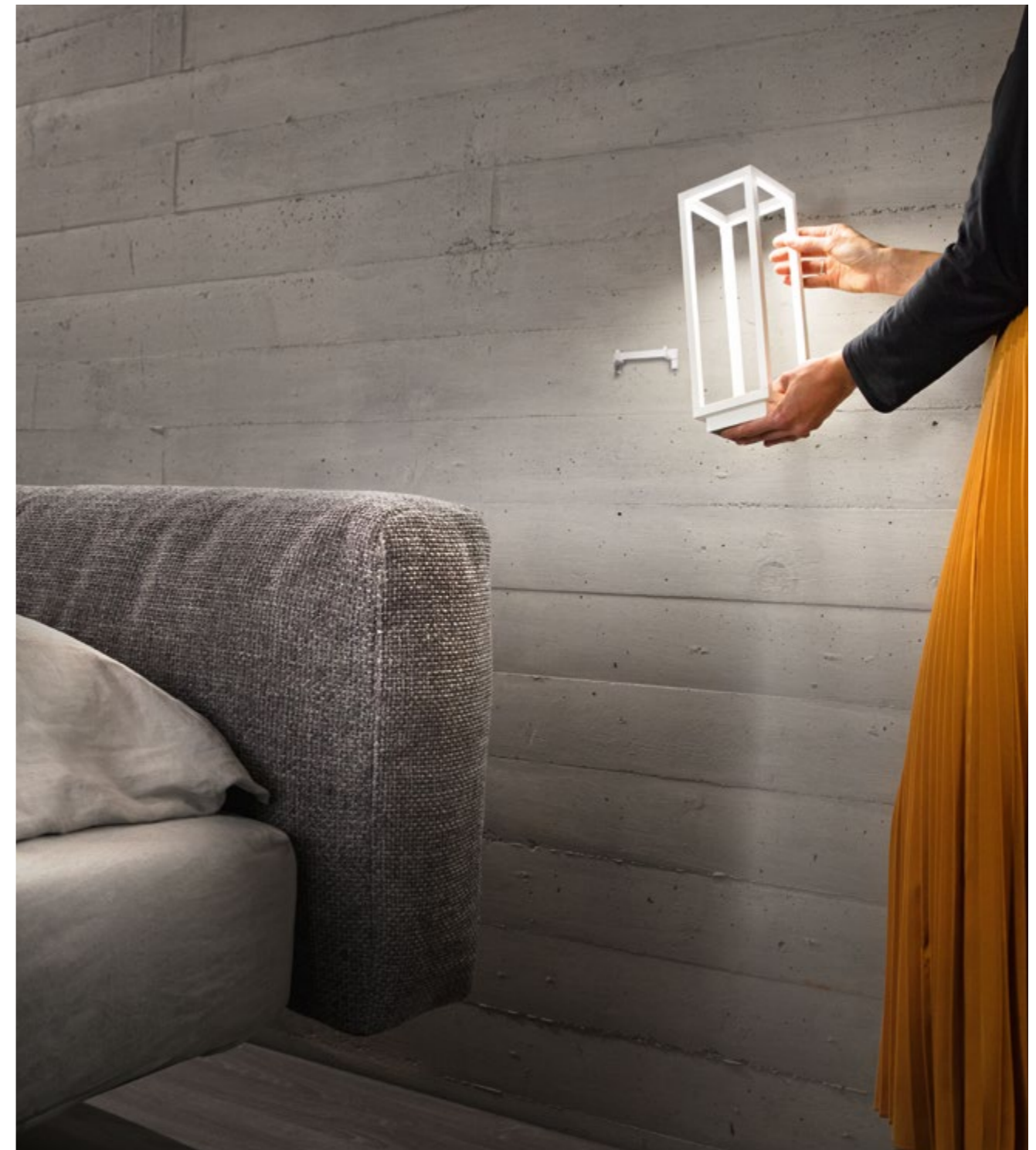

Home Solar

Paletto adatto all'uso esterno disponibile in due modelli: basso, alto. Ha struttura in pressofusione di alluminio verniciato grigio scuro o corten e diffusore in policarbonato trasparente. Home Solar è privo di collegamento alla rete elettrica e dotato di pannello solare, sensore crepuscolare, sensore di movimento e picchetto per installazione diretta su terreno. I sensori della lampada sono comandati da due interruttori: quando il sensore crepuscolare è attivo (☾) e rileva una luminosità ambientale minore di 150 Lux, la lampada si accende al 50% della sua intensità; quando anche il sensore di movimento è attivo (👤) e rileva un movimento, la lampada si accende al massimo della sua potenza per poi abbassarla al 10%.

È possibile acquistare separatamente una base zavorrata per una maggiore stabilità al terreno (pag. 176).

Bollard lamp for outdoor use available in two models: low and high. It has a dark gray or corten painted die-cast aluminum frame and a transparent polycarbonate diffuser. Home Solar is mains-independent and fitted with a solar panel, dusk sensor, motion sensor and peg for inserting it directly into the ground. The lamp sensors are controlled by two switches: when the dusk sensor is active (☾) and detects an ambient brightness of less than 150 Lux, the lamp switches on at 50% of its intensity. When the motion sensor is active (👤), too, and detects movement, the lamp switches on at full power, and then lower its intensity to 10%. A stabilizing base for greater stability can be purchased separately (pg. 176).



LINK TO VIDEO

PALETTO / BASE ZAVORRATA
BOLLARD / STABILIZING BASE

Home Solar bollard
dark gray → LD0257G3



Home Solar

Paletto Bollard

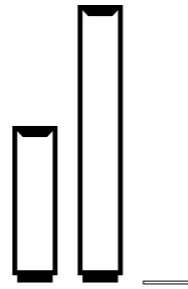

Dati tecnici

Technical data

LED

3,7 V | 3000 K | CRI>84 | 2,2W
415 lm | beam angle 50°

IP54

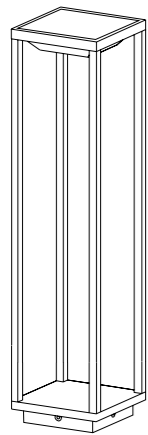

14 x 14 x 50 cm
5,5 x 5,5 x 19,7"

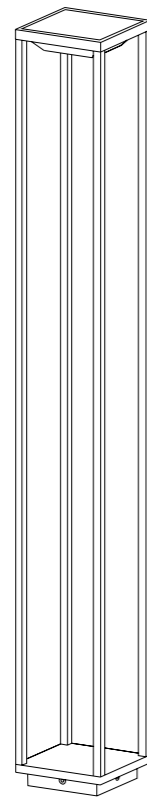

14 x 14 x 100 cm
5,5 x 5,5 x 39,4"

Dotata di sensore crepuscolare e di movimento
Fitted with dusk and motion sensors

Corpo in pressofusione di alluminio verniciato
Painted die-cast aluminum body

Schermo diffusore in policarbonato
Polycarbonate diffuser

Adatta all'uso esterno (lampada IP54)
Suitable for outdoor (lamp IP54)

Durata batteria: luce piena 5 - 6h; micro 14 - 18h
Work time : Full power 5 - 6h; energy saving 14 - 18h

Tempo di ricarica: 6/8 h (luce solare)
Charging time: 6/8 h (sunshine)

Batteria compatibile a pag 220
Compatible battery at pag 220

Cod. BAT04701906701900

Finiture Finishes



LD0256R3
Corten



LD0256G3
Grigio scuro / Dark gray



LD0257R3
Corten



LD0257G3
Grigio scuro / Dark gray

Componenti inclusi Components included

Picchetto
Peg



Home Solar

Base zavorrata Stabilizing base

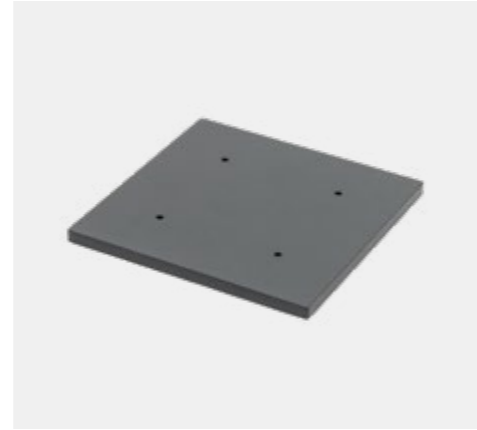

Dati tecnici Technical data



Finiture Finishes



LD0255R3
Corten



LD0255G3
Grigio scuro
Dark gray

Supporto in pressofusione d'alluminio verniciato
Painted die-cast aluminum element



Accessorio per stabilizzare la lampada senza ancorarla al terreno
Accessory to stabilise the lamp without anchoring it to the ground



16 x 16 x 0,8 cm
6,3 x 6,3 x 0,3"



Home Solar bollard dark gray +
Stabilizing base dark gray
→ **LD0256G3 + LD0255G3**

Super O^{PRO}

Design Studio Kairos

Super O è una collezione di lampade a batteria, portatili e ricaricabili che comprende i modelli da tavolo, terra (in tre varianti), terra sospesa (in tre varianti), parete (in due varianti) e a sospensione. Il modulo luminoso si fissa alla montatura di ciascun modello tramite un magnete, e - ruotando a 360° - permette di orientare la luce. Un controllo "touch" presente nella parte superiore del modulo permette l'accensione, la regolazione dell'intensità luminosa (dimmerazione a 4 step) e la selezione della temperatura di colore della luce. Grazie a un alto indice di protezione, le lampade della collezione sono utilizzabili anche all'esterno. Possiedono un sistema di controllo elettronico che monitora l'autonomia residua e garantisce un flusso luminoso costante fino all'esaurimento della batteria, permettendo di ottimizzare le ricariche ed effettuarle sempre in maniera corretta. Il modulo si rimuove in modo pratico e si ricarica comodamente connettendolo all'apposito disco di ricarica a contatto. Caricabatterie non incluso.

Super O is a collection of portable, rechargeable battery-operated lamps that includes the following: table, floor (three variants), ceiling-suspended floor (three variants) and wall (two variants) lamps, and a suspension lamp. The lighting module is attached to the frame of the lamps with a magnet. It can rotate 360°, allowing to direct the flow of light. On the head, a touch sensor allows you to switch it on, adjust the luminous intensity (4-step: 100%, 60%, 30%, 6%) and select the color temperature of the. With the high IP rating, the lamps can also be used outdoors. They feature an electronic control system that monitors the remaining autonomy and ensures a constant luminous flux until the battery runs out; recharging is therefore optimized and always properly done. The module can be easily removed from the frame and conveniently recharged by connecting it to the contact charging base; battery charger not included.



LINK TO VIDEO

TAVOLO / TERRA / TERRA SOSPESA / SOSPENSIONE / PARETE
TABLE / FLOOR / CEILING-SUSPENDED FLOOR / SUSPENSION / WALL



Super O lighting module
black → **LD1060N3**



Super O table lamp
white → **LD1152B3**



Super O floor lamp (2 Lighting modules)
black → **LD1155N3**



Super O ceiling-suspended floor lamp (1 Lighting module) black → **LD1157N3**



Super O suspension lamp white → **LD1153B3**

Super O wall lamp
white → **LD1151B3**



Super O wall lamp
black → **LD1150N3**



Super O^{PRO}

Tavolo Table

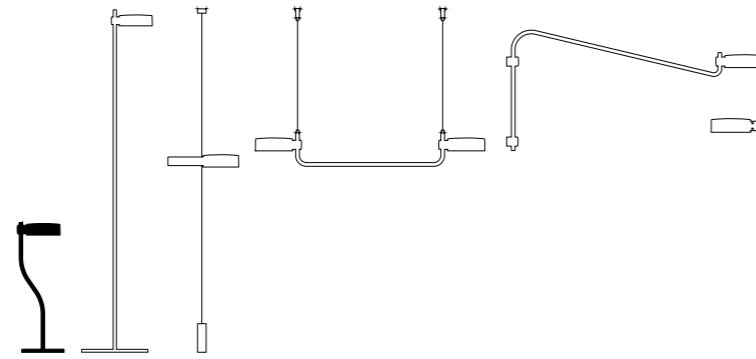

Dati tecnici

Technical data

LED TOUCH DIMMER

2700-3150-4000 K | CRI>90
287-331-336 lm | 3,5 W | IP65
5 V max 2A



Corpo in pressofusione di alluminio verniciato
Painted die-cast aluminum body

Schermo diffusore in policarbonato prismatico
Prismatic polycarbonate diffuser

Adatta all'uso esterno (lampada IP65) e interno
(lampada su base di ricarica IP20)
Suitable for outdoor (lamp IP65) and indoor use
(lamp on charging base IP20)

Durata di 100% 11 h - 60% 18 h - 30% 36 h - 6% 160 h
Battery lasts about 100% 11 h - 60% 18 h - 30% 36 h -
6% 160 h

Tempo di ricarica a 2A: 5 h
Charging time at 2A: 5 h

Pacco batteria al litio ricaricabile e sostituibile
Rechargeable and replaceable lithium battery pack

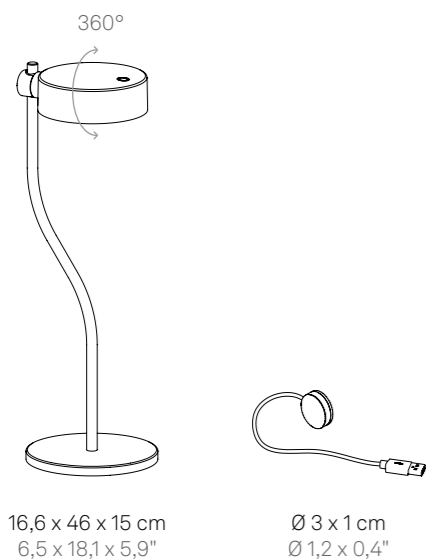

Componenti inclusi Components included

Disco per ricarica a contatto
Contact charging puck

Accessori non inclusi Accessories not included

Caricatore / Charger → **LD0300UC** (pg. 217)
5 V max 2,1 A | 100-240V | USB-A

Finiture Finishes



LD1152B3
Bianco / White
RAL 9003

LD1152N3
Nero / Black
RAL 9005



Super O^{PRO}

Terra Floor

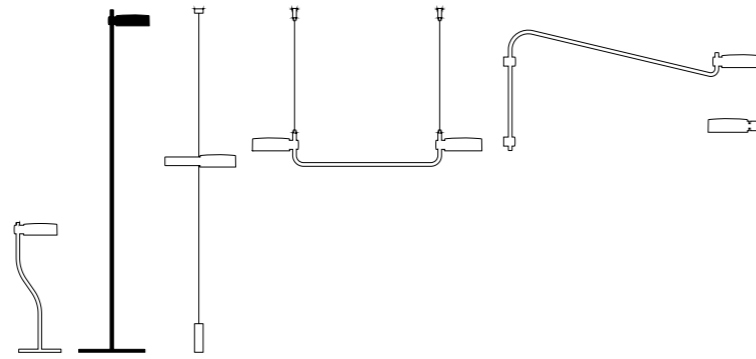

Dati tecnici

Technical data

LED TOUCH DIMMER

2700-3150-4000 K | CRI>90
287-331-336 lm | 3,5 W | IP65
5 V max 2A



Corpo in pressofusione di alluminio verniciato
Painted die-cast aluminum body

Schermo diffusore in policarbonato prismatico
Prismatic polycarbonate diffuser

Adatta all'uso esterno (lampada IP65) e interno
(lampada su base di ricarica IP20)
Suitable for outdoor (lamp IP65) and indoor use
(lamp on charging base IP20)

Durata di 100% 11 h - 60% 18 h - 30% 36 h - 6% 160 h
Battery lasts about 100% 11 h - 60% 18 h - 30% 36 h -
6% 160 h

Tempo di ricarica a 2A: 5 h
Charging time at 2A: 5 h

Pacco batteria al litio ricaricabile e sostituibile
Rechargeable and replaceable lithium battery pack

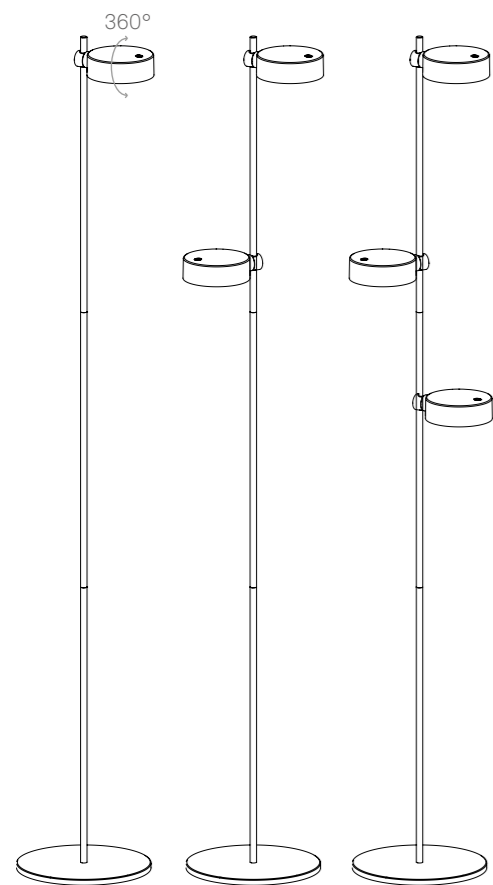

Ø 25 x 160 cm
Ø 9,8 x 63"

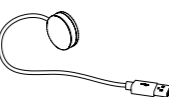

Ø 3 x 1 cm
Ø 1,2 x 0,4"

Componenti inclusi

Components included

Disco per ricarica a contatto
Contact charging puck

Accessori non inclusi

Accessories not included

Caricatore / Charger → **LD0300UC** (pg. 217)
5 V max 2,1 A | 100-240V | USB-A

Finiture Finishes

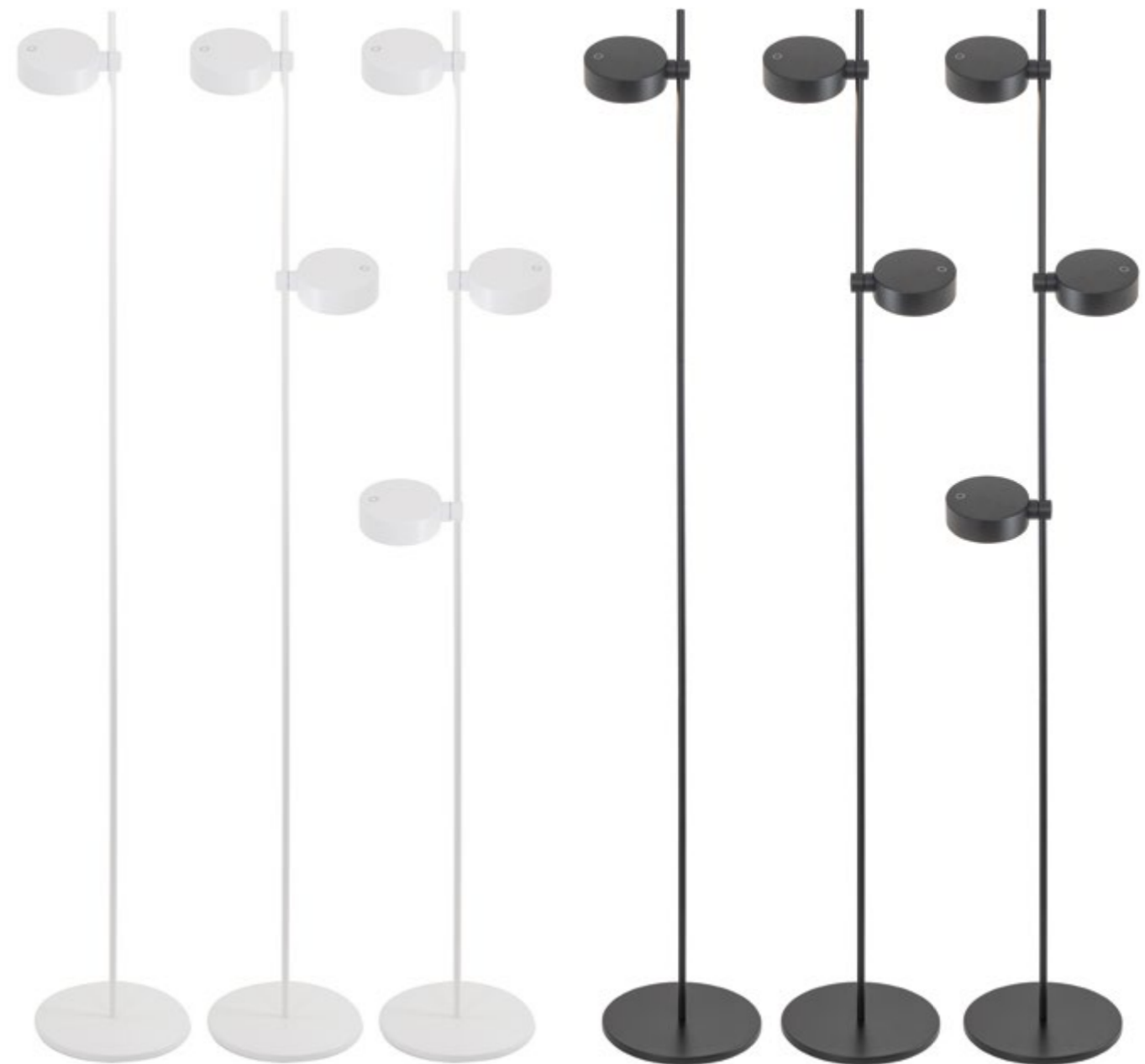

Bianco / White
RAL 9003

1 Modulo luce
1 Lighting module

LD1154B3

2 Moduli luce
2 Lighting modules

LD1155B3

3 Moduli luce
3 Lighting modules

LD1156B3

Nero / Black
RAL 9005

1 Modulo luce
1 Lighting module

LD1154N3

2 Moduli luce
2 Lighting modules

LD1155N3

3 Moduli luce
3 Lighting modules

LD1156N3

Super O^{PRO}

Terra sospesa Ceiling-suspended floor

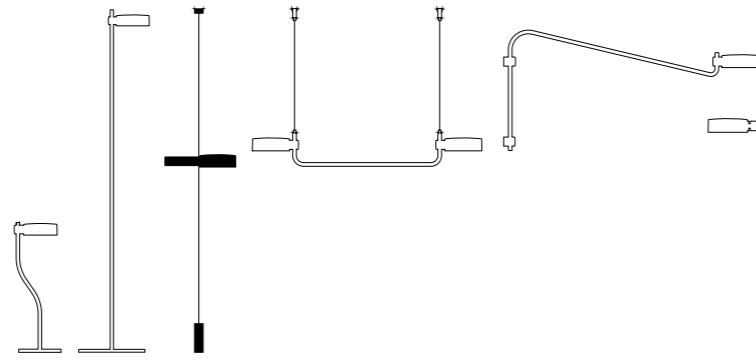

Dati tecnici

Technical data

LED TOUCH DIMMER

2700-3150-4000 K | CRI>90
287-331-336 lm | 3,5 W | IP65
5 V max 2A



Corpo in pressofusione di alluminio verniciato
Painted die-cast aluminum body

Schermo diffusore in policarbonato prismatico
Prismatic polycarbonate diffuser

Adatta all'uso esterno (lampada IP65) e interno
(lampada su base di ricarica IP20)
Suitable for outdoor (lamp IP65) and indoor use
(lamp on charging base IP20)

Durata di 100% 11 h - 60% 18 h - 30% 36 h - 6% 160 h
Battery lasts about 100% 11 h - 60% 18 h - 30% 36 h -
6% 160 h

Tempo di ricarica a 2A: 5 h
Charging time at 2A: 5 h

Pacco batteria al litio ricaricabile e sostituibile
Rechargeable and replaceable lithium battery pack

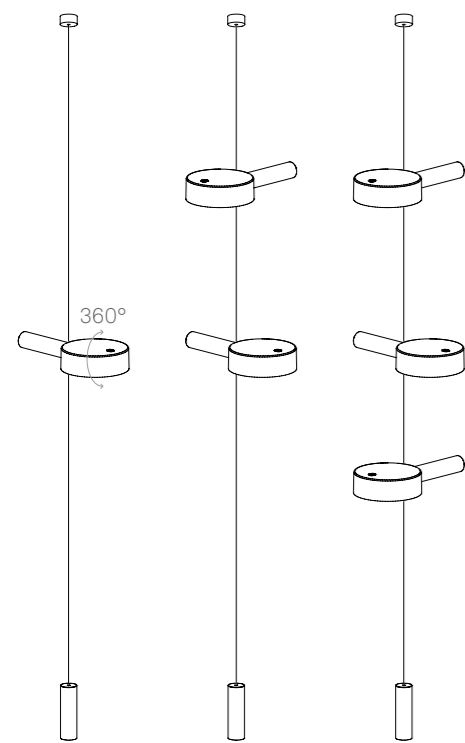
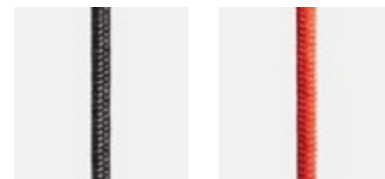

24,7 x 500 x 12,5 cm
9,7 x 196,9 x 4,9"

Ø 3 x 1 cm
Ø 1,2 x 0,4"

Componenti inclusi

Components included

Disco per ricarica a contatto / Contact charging puck

Cavo di colore grigio scuro / Dark gray cable

Cavo di colore rosso / Red cable

Contrappeso da terra / Floor counterweight

Contrappeso modulo luce

Counterweight for lighting module

Accessori non inclusi

Accessories not included

Caricatore / Charger → **LD0300UC** (pg. 217)

5 V max 2,1 A | 100-240V | USB-A

Finiture

Finishes

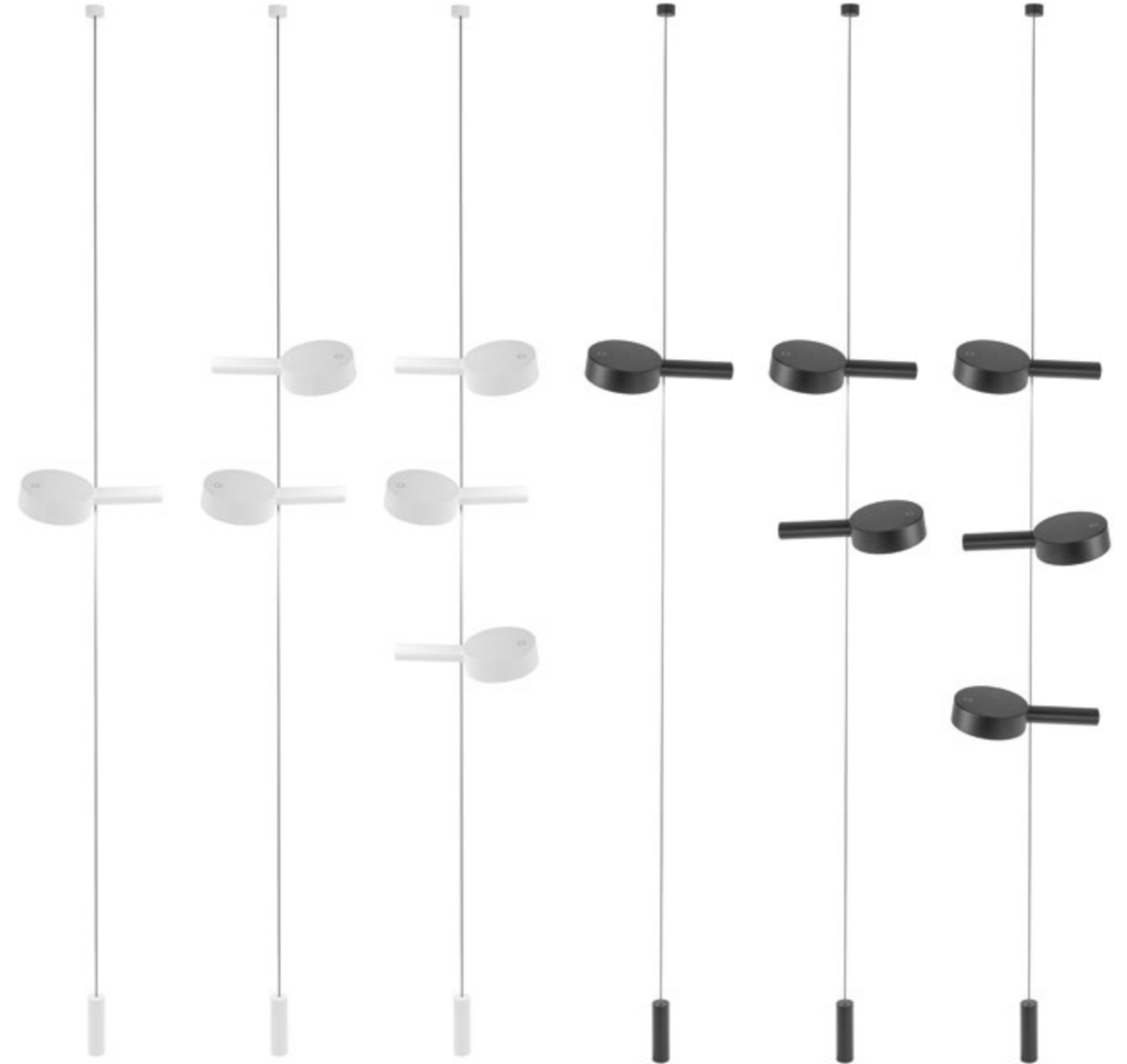

Bianco / White
RAL 9003

1 Modulo luce
1 Lighting module

LD1157B3

2 Moduli luce
2 Lighting modules

LD1158B3

3 Moduli luce
3 Lighting modules

LD1159B3

Nero / Black
RAL 9005

1 Modulo luce
1 Lighting module

LD1157N3

2 Moduli luce
2 Lighting modules

LD1158N3

3 Moduli luce
3 Lighting modules

LD1159N3

Super O^{PRO}

Sospensione Suspension

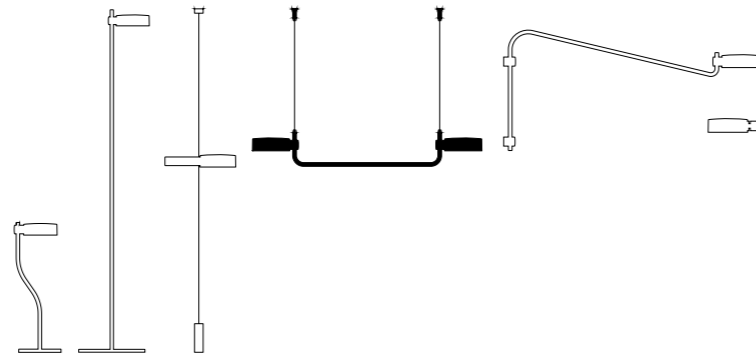

Dati tecnici

Technical data

LED TOUCH DIMMER

2700-3150-4000 K | CRI>90
2x 287-331-336 lm | 2x 3,5 W | IP65
5 V max 2A



Corpo in pressofusione di alluminio verniciato
Painted die-cast aluminum body

Schermo diffusore in policarbonato prismatico
Prismatic polycarbonate diffuser

Adatta all'uso esterno (lampada IP65) e interno
(lampada su base di ricarica IP20)
Suitable for outdoor (lamp IP65) and indoor use
(lamp on charging base IP20)

Durata di 100% 11 h - 60% 18 h - 30% 36 h - 6% 160 h
Battery lasts about 100% 11 h - 60% 18 h - 30% 36 h -
6% 160 h

Tempo di ricarica a 2A: 5 h
Charging time at 2A: 5 h

Pacco batteria al litio ricaricabile e sostituibile
Rechargeable and replaceable lithium battery pack

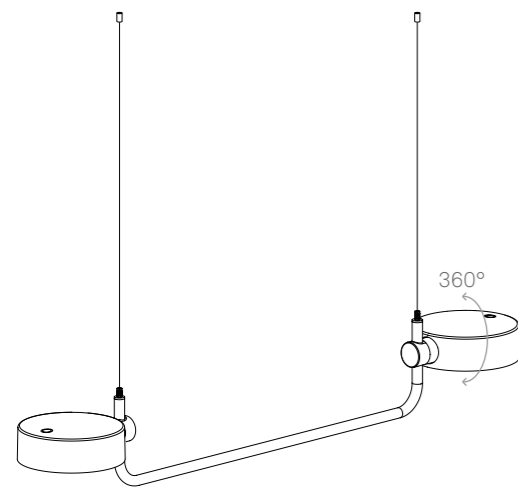

77 x 300 x 12,5 cm
30,3 x 118,1 x 4,9"

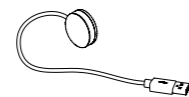

Ø 3 x 1 cm
Ø 1,2 x 0,4"

Componenti inclusi

Components included

Disco per ricarica a contatto
Contact charging puck

Accessori non inclusi

Accessories not included

Caricatore / Charger → **LD0300UC** (pg. 217)
5 V max 2,1 A | 100-240V | USB-A

Finiture

Finishes



LD1153B3

Bianco / White
RAL 9003

LD1153N3

Nero / Black
RAL 9005



Super O suspension lamp
black → **LD1153N3**

Super O^{PRO}

Parete Wall

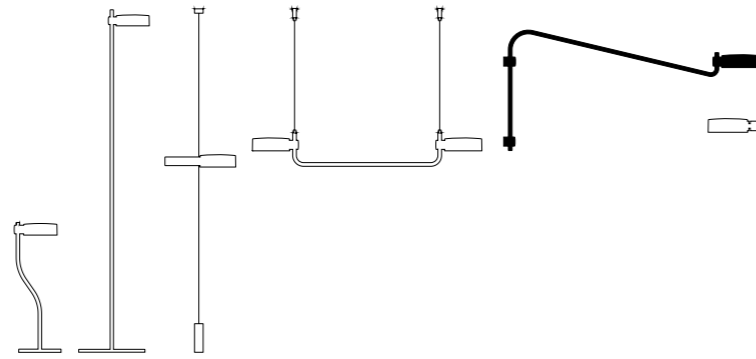

Dati tecnici

Technical data

LED TOUCH DIMMER

2700-3150-4000 K | CRI>90
287-331-336 lm | 3,5 W | IP65
5 V max 2A



Corpo in pressofusione di alluminio verniciato
Painted die-cast aluminum body

Schermo diffusore in policarbonato prismatico
Prismatic polycarbonate diffuser

Adatta all'uso esterno (lampada IP65) e interno
(lampada su base di ricarica IP20)
Suitable for outdoor (lamp IP65) and indoor use
(lamp on charging base IP20)

Durata di 100% 11 h - 60% 18 h - 30% 36 h - 6% 160 h
Battery lasts about 100% 11 h - 60% 18 h - 30% 36 h -
6% 160 h

Tempo di ricarica a 2A: 5 h
Charging time at 2A: 5 h

Pacco batteria al litio ricaricabile e sostituibile
Rechargeable and replaceable lithium battery pack

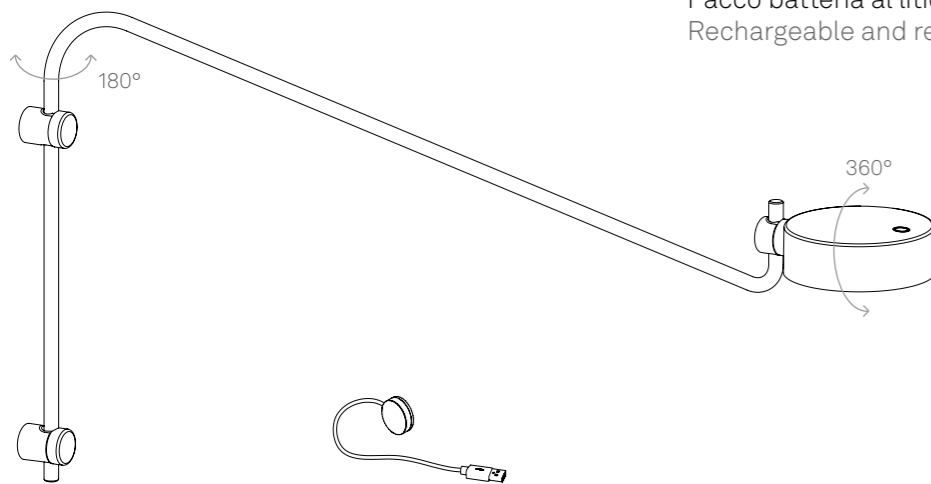

85,3 x 40,5 x 12,5 cm
33,6 x 15,9 x 4,9"

Ø 3 x 1 cm
Ø 1,2 x 0,4"

Componenti inclusi Components included

Disco per ricarica a contatto
Contact charging puck

Accessori non inclusi Accessories not included

Caricatore / Charger → **LD0300UC** (pg. 217)
5 V max 2,1 A | 100-240V | USB-A

Finiture Finishes



LD1151B3

Bianco / White
RAL 9003

LD1151N3

Nero / Black
RAL 9005



Super O wall lamp
black → **LD1151N3**

Super O^{PRO}

Parete Wall

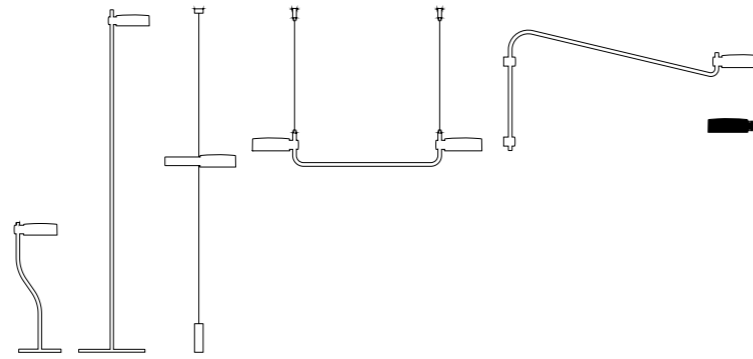

Dati tecnici

Technical data

LED TOUCH DIMMER

2700-3150-4000 K | CRI>90
287-331-336 lm | 3,5 W | IP65
5 V max 2A



Corpo in pressofusione di alluminio verniciato
Painted die-cast aluminum body

Schermo diffusore in policarbonato prismatico
Prismatic polycarbonate diffuser

Adatta all'uso esterno (lampada IP65) e interno
(lampada su base di ricarica IP20)
Suitable for outdoor (lamp IP65) and indoor use
(lamp on charging base IP20)

Durata di 100% 11 h - 60% 18 h - 30% 36 h - 6% 160 h
Battery lasts about 100% 11 h - 60% 18 h - 30% 36 h -
6% 160 h

Tempo di ricarica a 2A: 5 h
Charging time at 2A: 5 h

Pacco batteria al litio ricaricabile e sostituibile
Rechargeable and replaceable lithium battery pack

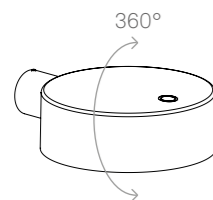

16,2 x 4,3 x 12,5 cm
6,4 x 1,7 x 4,9"

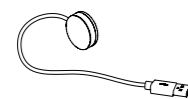

Ø 3 x 1 cm
Ø 1,2 x 0,4"

Componenti inclusi Components included

Disco per ricarica a contatto
Contact charging puck

Accessori non inclusi Accessories not included

Caricatore / Charger → **LD0300UC** (pg. 217)
5 V max 2,1 A | 100-240V | USB-A

Finiture Finishes



LD1150B3
Bianco / White
RAL 9003



LD1150N3
Nero / Black
RAL 9005



Pencil^{PRO}

Design Federico de Majo



Progetto selezionato dall'Osservatorio Permanente del Design ADI per ADI Design Index 2022.

Project selected by the ADI Permanent Design Observatory for ADI Design Index 2022.

Pencil è un sistema di illuminazione composto da un modulo luminoso a batteria portatile e ricaricabile e dagli accessori dedicati che lo trasformano in lampada da terra, tavolo, parete e a sospensione.

Il modulo Pencil può dunque usato nel suo alloggiamento fisso, ma anche rimosso, portato con sé da un ambiente all'altro, e usato autonomamente: continuerà a funzionare a lungo, fino all'esaurimento della carica accumulata (fino a 58 ore). La sorgente a LED produce una luce intensa e ben direzionata, che grazie alla dimmerazione a 4 step e alla funzione di selezione della temperatura di colore consente di calibrare con precisione l'illuminazione di spazi pubblici e privati, anche outdoor.

Pencil is a lighting system consisting of a rechargeable battery-powered cordless light module, and the dedicated accessories that transform it into a wall, pendant, and floor/table lamp. The module can therefore be used in its fixed housing, but also removed and carried from one place to another, and used independently: it will continue to function for a long time, until the accumulated charge power runs out (up to 58 h). The LED source produces a bright, well-directed light, which - thanks to the 4-step dimming and the color temperature selection functions - provides the most appropriate illumination for public and private spaces, also outdoors.

MODULO LUCE / CARICABATTERIE / BASE DI STAZIONAMENTO E RICARICA / SUPPORTI TAVOLO / SUPPORTI PARETE ORIZZONTALE / SUPPORTO PARETE VERTICALE / SUPPORTO SOSPENSIONE VERTICALE / SUPPORTI SOSPENSIONE ORIZZONTALE / LIGHTING MODULE / BATTERY CHARGER / DOCKING AND CHARGING STATION / ROTATING DOCKING STATION / TABLE BASES / HORIZONTAL WALL LAMP BRACKETS / VERTICAL WALL LAMP KIT / VERTICAL SUSPENSION KIT / HORIZONTAL SUSPENSION KIT



LINK TO VIDEO



Pencil lighting module large white
+ docking station white
→ **LD0802B3 + LD0810B3**
Osteria Stasera Corder - Treviso, Italy
Photo phEsci Francesco Esci



Pencil lighting module small white
+ table bases
→ **LD0800B3 + LD081400**

Pencil^{PRO}

Modulo luce Lighting module



Dati tecnici

Technical data

LED TOUCH DIMMER

2700-3150-4000 K | CRI>90
580-650-680 lm | 6 W | IP65
19 V max 2,5 A

LED TOUCH DIMMER

2700-3150-4000 K | CRI>90
1160-1300-1360 lm | 12 W | IP65
19 V max 2,5 A

LED TOUCH DIMMER

2700-3150-4000 K | CRI>90
1740-1950-2040 lm | 18 W | IP65
19 V max 2,5 A

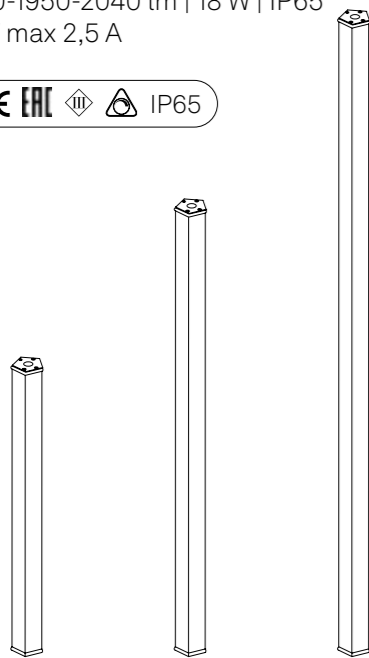

Ø 5,4 x 50 cm Ø 5,4 x 98 cm Ø 5,4 x 146 cm
Ø 2,1" x 19,7" Ø 2,1" x 38,6" Ø 2,1" x 57,5"

Pacchi batterie al litio ricaricabili e sostituibili
Rechargeable and replaceable lithium battery packs

Durata 8 - 58 h, in base alla regolazione del flusso luminoso

Battery lasts 8 - 58 h, depending on the luminous flux setting.

Ricarica con connettore 3.5/1.3, oppure a contatto (quando usato su base ricarica)

Rechargeable with a 3.5/1.3 connector, or by contact (when used with the charging base)

Tempi di ricarica a 2,5 A: 6/9/12 h (rispettivamente per misura piccola/media/grande)

Recharging times at 2.5 A: 6/9/12 h (for small/medium/ large size respectively)

Corpo in estrusione d'alluminio verniciato
Painted extruded aluminum fixture

Diffusore in policarbonato opale satinato
Satin opal polycarbonate diffuser

Adatta all'uso esterno (lampada IP65) e interno (lampada su base di ricarica IP20)

Suitable for outdoor (lamp IP65) and indoor use (lamp on charging base IP20)

Resistenza agli urti (IK07) e alla nebbia salina (1500h)
Impact resistance (IK07) and salt spray resistance (1500h)

Componente non incluso Component not included

Caricatore / Charger → **LD0800CS** (pg. 217) *
19 V max 2,5 A | 100-240V

* Componente necessario, da acquistare separatamente
* Necessary accessory, yet it must be purchased separately

Finiture Finishes



Bianco / White
RAL 9003

Corten

Grigio scuro / Dark gray
RAL 7012

Small

LD0800B3

LD0800R3

LD0800G3

Medium

LD0801B3

LD0801R3

LD0801G3

Large

LD0802B3

LD0802R3

LD0802G3

Caricabatterie Battery charger

Componente necessario, da acquistare separatamente (**LD0800CS**)
Necessary accessory, yet it must be purchased separately (**LD0800CS**)

47,5W • 100-240V • 50-60Hz
19 V max 2,5A

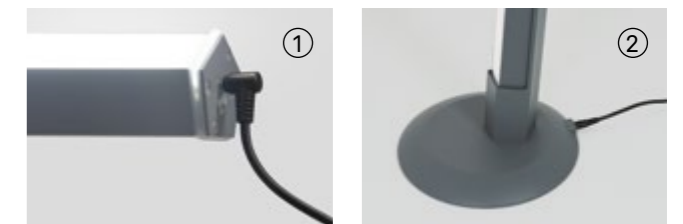
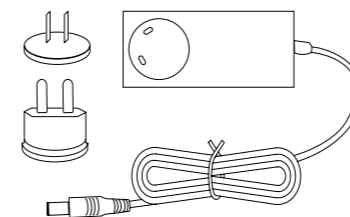

Il caricabatterie permette di ricaricare Pencil in due modi: collegando il cavo (fig. 1) direttamente al modulo luminoso; oppure collegando il cavo alla base di stazione e ricarica in cui il modulo viene posizionato (fig. 2).

The battery charger allows the recharging of Pencil in two ways: either by connecting cable directly to the lighting module (fig. 1); or by connecting the cable to the docking station where the module is placed (fig. 2).

Pencil^{PRO}

Base di stazionamento e ricarica*

Docking and charging station*

* Solo se connesso al caricatore (non incluso)

* Only if connected with the charger (not included)



Dati tecnici Technical data

19 V max 3,16A

CE IP20

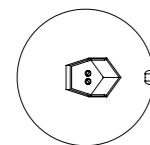
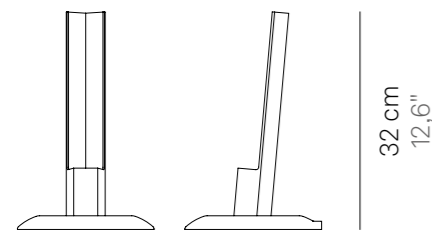

Ø 20 cm
Ø 7,8"

Finiture Finishes



LD0810B3
Bianco
White
RAL 9003



LD0810R3
Corten



LD0810G3
Grigio scuro
Dark gray
RAL 7012

Corpo in alluminio verniciato
Painted aluminum fixture

Componente non incluso
Component not included

Caricabatterie (pag. 217)
Charger (pg. 217)

A dual-function accessory: it is mainly used as a docking station, turning the lighting module Pencil into a floor or table lamp. Connected to the battery charger, it becomes a contact charging base for the lighting module. The lighting module can be used in its fixed housing, or detached and carried from one place to another.

Accessorio con doppia funzione: è principalmente una base di stazionamento, che trasforma Pencil in lampada da terra o da tavolo; collegato al caricabatterie, diventa una base di ricarica a contatto per il modulo luminoso. Il modulo luminoso può essere usato nel suo alloggiamento fisso, ma anche rimosso e portato con sé da un ambiente all'altro.

Pencil^{PRO}

Supporti tavolo Table bases



Dati tecnici Technical data

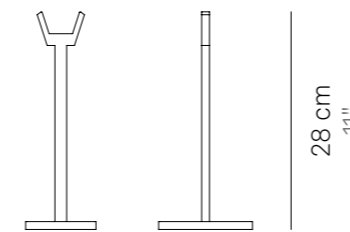

12 cm
4,7"

Finiture Finishes



LD081400
Trasparente / Clear

Supporti in PMMA trasparente
Transparent PMMA structure

Elementi che trasformano Pencil in una lampada da tavolo. Il modulo luminoso può essere usato nel suo supporto, ma anche rimosso e portato con sé da un ambiente all'altro.

Elements that turn Pencil into a table lamp. The lighting module can be used in its fixed housing or detached and carried from one place to another.

Pencil^{PRO}

Supporti parete orizzontale Horizontal wall lamp brackets

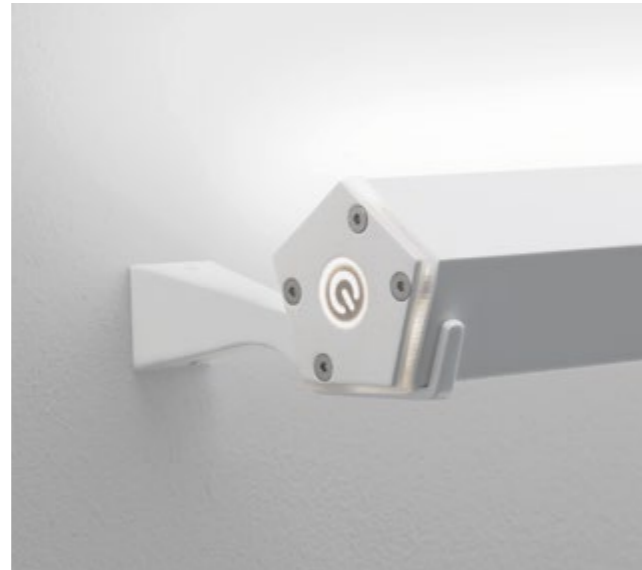

Dati tecnici Technical data

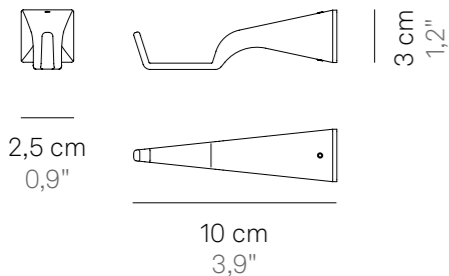

Finiture Finishes



LD0813B3
Bianco
White
RAL 9003



LD0813R3
Corten



LD0813G3
Grigio scuro
Dark gray
RAL 7012

Supporti in pressofusione d'alluminio verniciato
Painted die-cast aluminum elements

Brackets that turn Pencil into a horizontal wall lamp. The lighting module can be used in its fixed housing or detached and carried from one place to another.

Supporti che trasformano Pencil in una lampada da parete orizzontale. Il modulo luminoso può essere usato nel suo supporto fisso, ma anche rimosso e portato con sé da un ambiente all'altro.

Pencil^{PRO}

Supporto parete verticale Vertical wall lamp kit



Dati tecnici Technical data

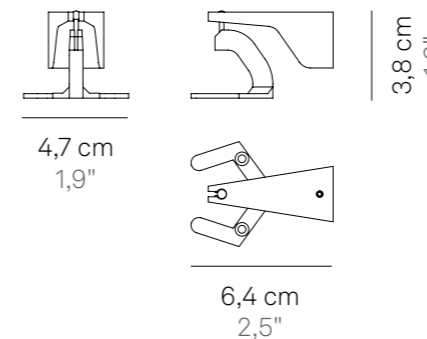

Finiture Finishes



LD0815B3
Bianco
White
RAL 9003



LD0815R3
Corten



LD0815G3
Grigio scuro
Dark gray
RAL 7012

Supporto in pressofusione d'alluminio verniciato con particolari cromati
Painted die-cast aluminum element with chromed details

Elemento che trasforma Pencil in una lampada da parete verticale, che ruota sul proprio asse longitudinale a 360°, in entrambi i sensi. Il modulo luminoso può essere usato nel suo supporto fisso, ma anche rimosso e portato con sé da un ambiente all'altro.

Element that turns Pencil into a vertical wall lamp, rotating on its longitudinal axis by 360°, in both directions. The lighting module can be used in its fixed housing or detached and carried from one place to another.

Pencil^{PRO}

Supporto sospensione verticale



Vertical suspension kit

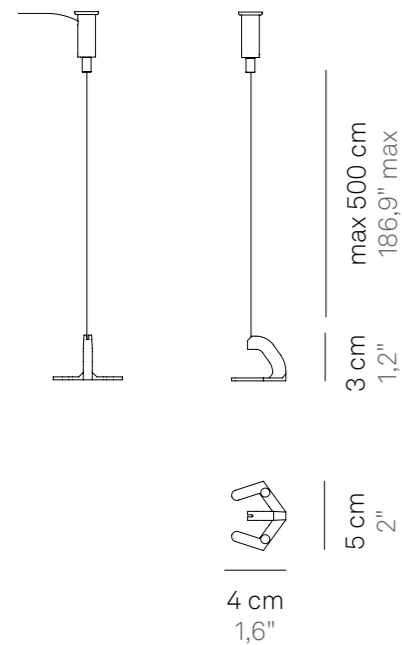

Dati tecnici
Technical data

Finiture
Finishes



		
LD0811B3 Bianco White RAL 9003	LD0811R3 Corten	LD0811G3 Grigio scuro Dark gray RAL 7012

Supporto in pressofusione d'alluminio verniciato con particolari cromati
Painted die-cast aluminum element with chromed details

Componenti inclusi
Components included

Cavo in acciaio e staffe
Steel cable and brackets

Element that turns Pencil into a vertical suspension lamp. The lighting module can be used in its fixed housing, or detached and carried from one place to another.

Elemento che trasforma Pencil in una lampada a sospensione verticale. Il modulo luminoso può essere usato nel suo supporto fisso, ma anche rimosso e portato con sé da un ambiente all'altro.

Pencil^{PRO}

Supporti sospensione orizzontale



Horizontal suspension kit

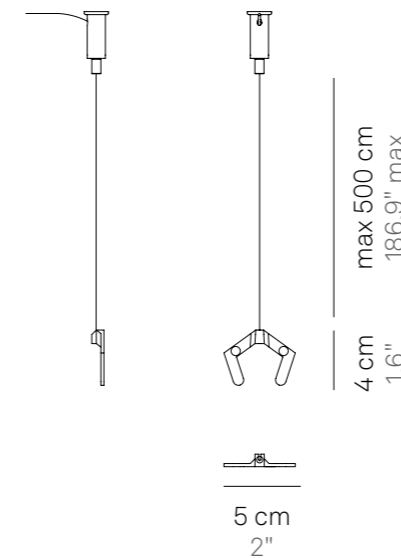

Dati tecnici
Technical data

Finiture
Finishes



		
LD0812B3 Bianco White RAL 9003	LD0812R3 Corten	LD0812G3 Grigio scuro Dark gray RAL 7012

Supporto in pressofusione d'alluminio verniciato con particolari cromati
Painted die-cast aluminum element with chromed details

Componenti inclusi
Components included

Cavo in acciaio e staffe
Steel cable and brackets

Elements that turn Pencil into a horizontal suspension lamp. The lighting module can be used in its fixed housing or detached and carried from one place to another.

Elementi che trasformano Pencil in una lampada a sospensione orizzontale a luce diretta. Il modulo luminoso può essere usato nel suo supporto fisso, ma anche rimosso e portato con sé da un ambiente all'altro.

Liolà

Design Studio Kairos

Collezione di piani d'appoggio multiuso con gambe in legno massello, disponibili in tre varianti: basso, alto oppure XXL.

Estremamente versatili, possono essere usati come tavolini, porta piante, svuota tasche... ma anche per appendere indumenti.

Realizzati in collaborazione con artigiani e laboratori selezionati, i Liolà sono progettati per un uso professionale nel settore ristorazione, ma sono adatti anche all'uso domestico. La ricerca sulle forme e sui materiali e la cura del dettaglio caratterizzano anche questo prodotto Zafferano, che anticipa un orientamento della gamma verso una concezione più "lifestyle".

Collection of multipurpose three-legged, standing tops available in three versions: low, tall or XXL.

Extremely versatile, they can be used as side tables, plant holders, dresser valet... but also as clothes hanger.

Made in collaboration with selected artisans and workshops, they are designed for professional use in restaurants, but are also suitable for home use.

The research of shapes and materials and the attention to details characterize these Zafferano products, which anticipate the orientation of the range towards a more "lifestyle" concept.

PIANO D'APPOGGIO MULTIUSO BASSO / PIANO D'APPOGGIO MULTIUSO ALTO / PIANO D'APPOGGIO MULTIUSO XXL
MULTIPURPOSE THREE-LEGGED SMALL / MULTIPURPOSE THREE-LEGGED HIGH / MULTIPURPOSE THREE-LEGGED XXL



LINK TO VIDEO



Liolà multipurpose three-legged high
white - natural wood → **ZLS0101**
Super O table lamp white → **LD1152B3**



Liola multipurpose three-legged XXL
white - natural wood → **ZLS0201**



Liola multipurpose three-legged small
white - natural wood → **ZLS0001**

Liolà

Piano d'appoggio multiuso Multipurpose three-legged



Dati tecnici Technical data

Piano in termoplastico
Thermoplastic top
Gambe in legno di frassino
Wood legs

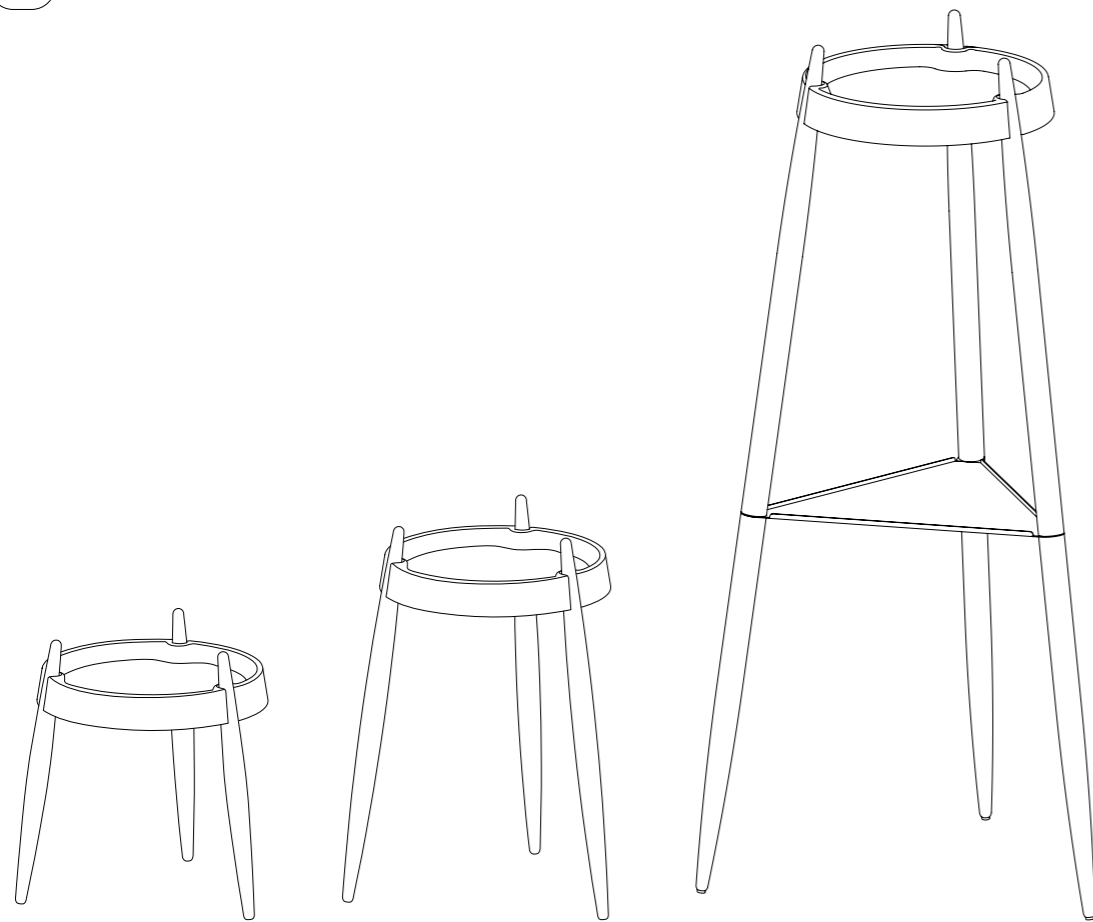

Ø 49 x 47 cm
Ø 19,3 x 18,5 in

Ø 54,7 x 67 cm
Ø 21,5 x 26,4 in

Ø 73,8 x 135 cm
Ø 29 x 53,1 in

Finiture Finishes



ZLS0001
Bianco - Frassino naturale
White - Natural wood



ZLS0002
Bianco - Frassino nero
White - Black wood



ZLS0004
Nero - Frassino naturale
Black - Natural wood



ZLS0005
Nero - Frassino nero
Black - Black wood



ZLS0101
Bianco - Frassino naturale
White - Natural wood



ZLS0102
Bianco - Frassino nero
White - Black wood



ZLS0104
Nero - Frassino naturale
Black - Natural wood



ZLS0105
Nero - Frassino nero
Black - Black wood



ZLS0201
Bianco - Frassino naturale
White - Natural wood



ZLS0202
Bianco - Frassino nero
White - Black wood



ZLS0204
Nero - Frassino naturale
Black - Natural wood



ZLS0205
Nero - Frassino nero
Black - Black wood

Basi di ricarica e caricatori

Contact charging base and charger



Sister Light Wi-Fi collection
Base di ricarica a contatto
Contact charging base
LD1080RB



Sister Light Wi-Fi table lamp
Adattatore per base di ricarica
Charging base adapter
LD1080BS



Poldina, Poldina mini
Base di ricarica a contatto
Contact charging base
LD0350RB



Poldina micro
Base di ricarica a contatto
Contact charging base
LD0490RB



Poldina L desk
Base di ricarica a contatto
Contact charging base
LD0395RB

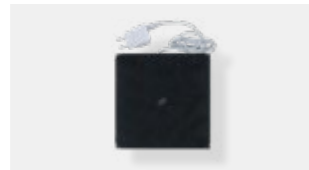

Poldina L
Base di ricarica a contatto
Contact charging base
LD0390RB



Poldina XXL
Base di ricarica a contatto
Contact charging base
LD0360RB



Poldina lamp with peg,
Poldina suspension lamp,
Poldina wall lamp
Base di ricarica a contatto
Contact charging base
LD0688RB



Poldina Reverso
Base di ricarica a contatto
Contact charging base
LD0420RB

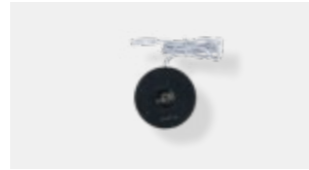

Poldina Stopper
Base di ricarica a contatto
Contact charging base
LD0349RB



Amelie collection
Base di ricarica a contatto
Contact charging base
LD1090RB



Circe
Base di ricarica a contatto
Contact charging base
LD1005RB



Pina
Base di ricarica a contatto
Contact charging base
LD0650RB

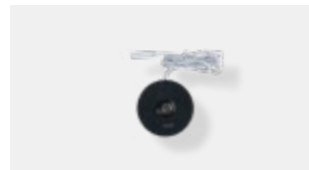

Swap collection
Base di ricarica a contatto
Contact charging base
LD1030RB



Ofelia
Base di ricarica a contatto
Contact charging base
LD0870RB



Ofelia micro
Base di ricarica a contatto
Contact charging base
LD1880RB



Olivia, Olivia mini
Base di ricarica a contatto
Contact charging base
LD0850RB



Olivia micro
Base di ricarica a contatto
Contact charging base
LD1840RB

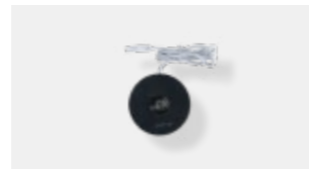

Push-up
Base di ricarica a contatto
Contact charging base
LD1050RB



Olimpia
Base di ricarica a contatto
Contact charging base
LD0900RB



Dama
Base di ricarica a contatto
Contact charging base
LD0610RB



Home
Base di ricarica a contatto
Contact charging base
LD0258RB

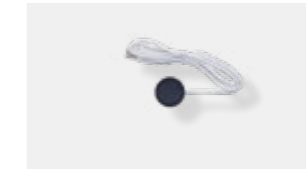

Super O collection
Disco per ricarica a contatto
Contact charging puck
LD1060RB



LD0800CS
Caricabatterie con connettore
3.5/1.3
(Pencil modulo luce, Pencil base ricarica)
Charger with a 3.5/1.3 connector
(Pencil lighting module, Pencil
charging base)
48W
INPUT: AC 100-240V | 50-60Hz
OUTPUT: 19 V - max 2,5 A



LD0300UC
Caricabatterie con doppia entrata
USB-A e spina intercambiabile
(EU/USA/UK)
Dual USB-A port power charger
and an interchangeable plug
suitable for EU/USA/UK
(Sister Light, Super O)
INPUT: AC 100-240V | 50-60Hz
OUTPUT: 5 V - max 2,1A



LD0280UA
Caricabatterie con entrata USB-A e
cavo di ricarica con entrata USB-C
Charger with USB-A input and
charging cable with USB-C input
INPUT: AC 100-240V | 50-60Hz
OUTPUT: 5 V - max 1A



LD0490UA
Caricabatterie con entrata USB-A
(Poldina micro, Poldina sospensione,
Poldina parete, Poldina picchetto,
Swap, Swap mini, Push-up)
USB-A port power charger
(Poldina micro table lamp, Poldina
suspension lamp, Poldina wall lamp,
Poldina lamp with peg, Swap, Swap
mini table lamp, Push-up table
lamp)
INPUT: AC 100-240V | 50-60Hz
OUTPUT: 5 V - max 1A

Accessori e ricambi

Accessories and spare parts

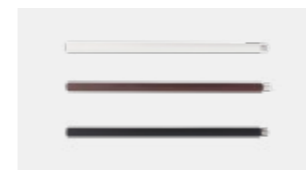

Poldina
Prolunga stelo aggiuntiva
Additional stem extension
LD0283B3 Bianco / White
LD0283R3 Corten
LD0283N3 Grigio scuro / Dark Gray



Poldina Reverso
Contenitore multiuso
Multipurpose container tray
LD0420V1



Poldina Stopper
Tappo per testa in silicone
Silicone head plug
LD0349TP

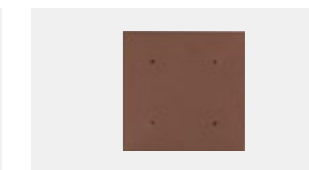

Home Solar
Base zavorrata
Stabilizing base
LD0255R3 Corten
LD0255G3 Grigio scuro / Dark gra



Super O
Modulo luce aggiuntivo
Additional lighting module
LD1060B3 Bianco / White
LD1060N3 Nero / Black



Super O
Contrappeso per modulo luce
Counterweight for additional
light module
LD1063B3 Bianco / White
LD1063N3 Nero / Black

LD0350RP

Base di ricarica a contatto multipla (max 6 posti) / Multi-contact charging base (max 6 slots)

→ Sister Light Wi-Fi, Poldina, Poldina mini, Poldina Reverso, Pina, Swap, Swap mini, Push-up, Home, Dama, Olimpia

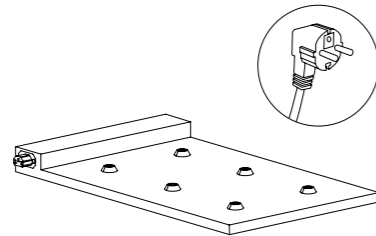
32,7 x 51 x 5,8 cm
14,6" x 20" x 2,3"30W
INPUT: AC 100-240V | 50-60Hz
OUTPUT: 5 V max 6A

Base di ricarica a contatto multipla (max 6 posti) e modulare: più basi possono essere collegate in sequenza per caricare contemporaneamente più lampade. Particolarmente adatto all'uso professionale.

Modular multi-contact (max 6 slots) charging base: it can be connected in sequence to simultaneously charge multiple sets of lamps. Particularly suitable for professional use.

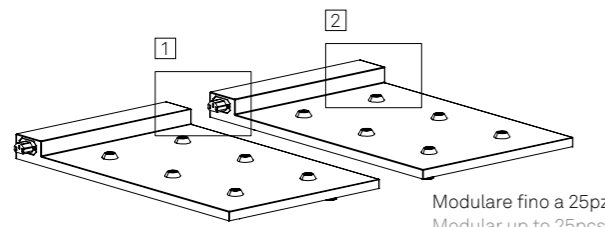
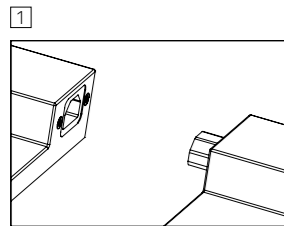
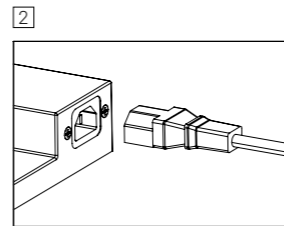
Modulare fino a 25pz
Modular up to 25pcs**LD0490RP**

Base di ricarica a contatto multipla (max 12 posti) / Multi-contact charging base (max 12 slots)

→ Poldina micro

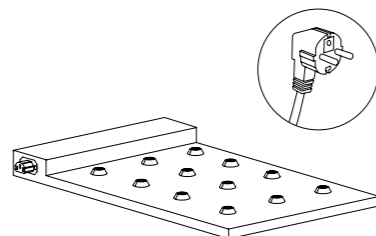
32,7 x 51 x 5,8 cm
14,6" x 20" x 2,3"60W
INPUT: AC 100-240V | 50-60Hz
OUTPUT: 5 V max 12A

Base di ricarica a contatto multipla (max 12 posti) e modulare: più basi possono essere collegate in sequenza per caricare contemporaneamente più lampade. Particolarmente adatto all'uso professionale.

Modular multi-contact (max 12 slots) charging base: it can be connected in sequence to simultaneously charge multiple sets of lamps. Particularly suitable for professional use.

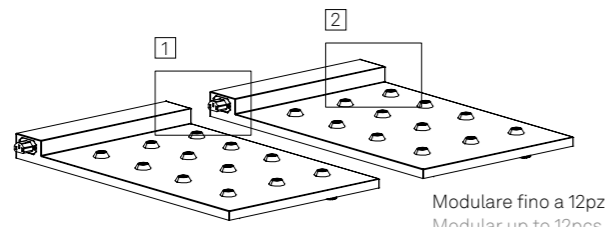
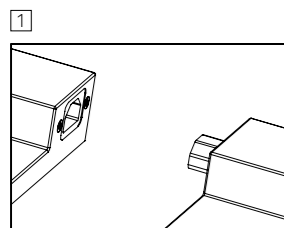
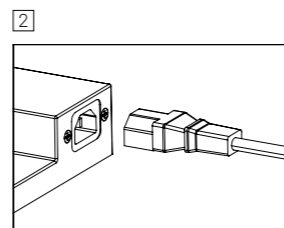
Modulare fino a 12pz
Modular up to 12pcs**LD0870RP**

Base di ricarica a contatto multipla (max 6 posti) / Multi-contact charging base (max 6 slots)

→ Amelie, Circe, Olivia, Olivia mini, Olivia micro, Ofelia, Ofelia micro

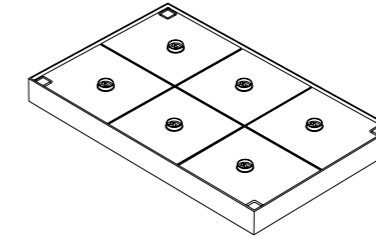
29 x 47 x 4 cm
11,4" x 18,5" x 1,5"45W
INPUT: AC 100-240V | 50-60Hz
OUTPUT: 9 V max 5A

Base di ricarica a contatto multipla (max 6 posti) e modulare: più basi possono essere impilate (fino a max 3 livelli) per caricare contemporaneamente più lampade. Particolarmente adatto all'uso professionale.

Modular multi-contact (max 6 slots) charging base: it can be stacked (up to max 3 levels) to simultaneously charge multiple sets of lamps. Particularly suitable for professional use.

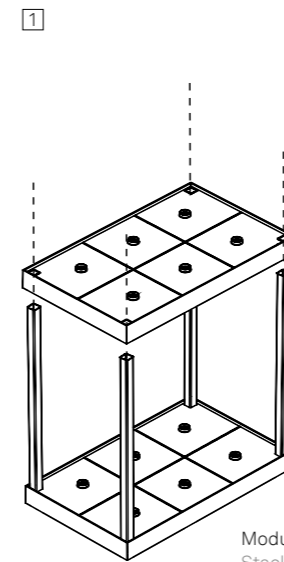
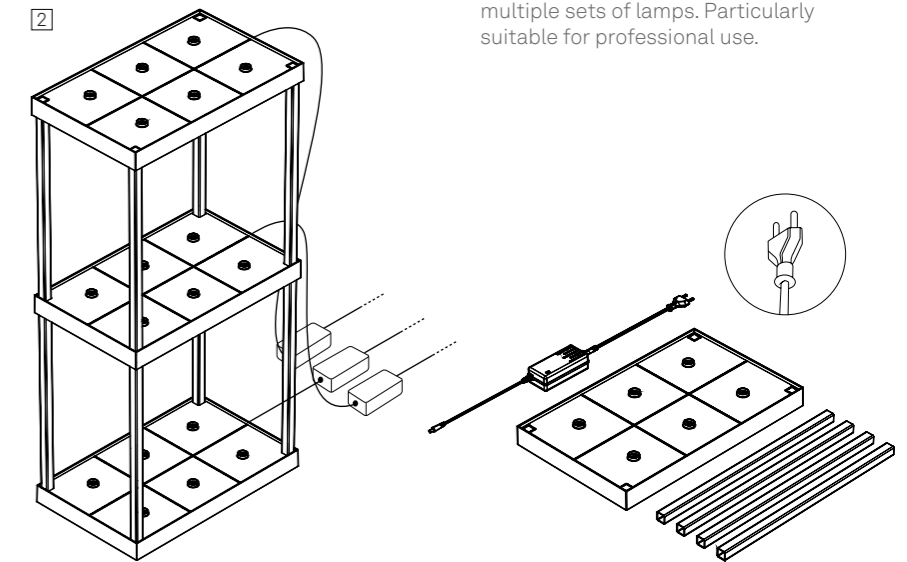
Modulare fino a 3 livelli.
Stackable up to 3 levels.**LD0340RA-12**

Caricatore multiplo 12 prese USB / 12 x USB ports multi charger

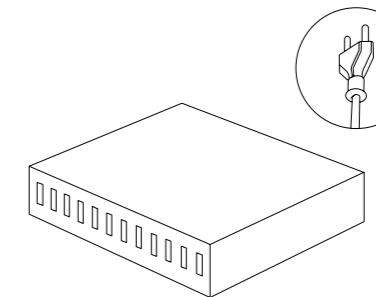
12,7 x 15,2 x 3,3 cm
5" x 6" x 1,3"150W
INPUT: AC 100-240V | 50-60Hz
OUTPUT: 5 V - max 2,4A (12 pcs.)

Caricatore multipresa USB (12 x USB-A). Permette la carica di max 12 dispositivi contemporaneamente. Particolarmente adatto all'uso professionale. USB multi-socket charger (12 x USB-A). Can charge of up to 12 devices simultaneously. Particularly suitable for professional use.

Batterie ricaricabili

Rechargeable batteries

Le batterie ricaricabili sono soggette ad usura.

La vita delle batterie, il cui standard è di circa 450 ricariche, può essere ridotta da alcuni fattori come: ① la modalità non corretta di ricarica (la lampada va ricaricata quando è scarica: circa il 10% della sua autonomia residua); ② lunghi periodi di stazionamento senza utilizzo; ③ lunghi periodi di stazionamento su base di ricarica in tensione anche se la lampada risulta carica; ④ l'utilizzo di accessori non originali per la ricarica; ⑤ l'esposizione del prodotto a temperature molto alte o molto fredde. Quando le lampade non si ricaricano più o l'autonomia risulta molto ridotta, le batterie devono essere sostituite. I ricambi delle lampade ricaricabili Zafferano sono disponibili a catalogo e identificati con apposito codice. La garanzia sulle batterie è valida solo per difetti di fabbricazione, che si manifestano al primo utilizzo.

All rechargeable batteries are subject to wear when used.

The life of batteries, which can generally be recharged 450 times, may be reduced by certain factors: ① incorrect recharging mode (the lamp must be recharged when it is flat: about 10% of its remaining autonomy); ② when left unused for a long time; ③ when left for a long time on a live recharging base even if the lamp is recharged; ④ when non-original accessories are used for recharging; ⑤ when the product is exposed to very high or very low temperatures. When the lamps no longer recharge or their autonomy after recharging is very short, the batteries must be replaced. Spare parts for Zafferano rechargeable lamps can be found in the catalogue and identified by a special code. The warranty for batteries is only valid for manufacturing defects, if occurred at first use.

BAT04701906701900 Pacco batteria sostitutiva singola (necessario <u>1 pz.</u> per Home Solar ; necessari <u>2 pz.</u> per Pina, Push-up, Home ; necessari <u>3 pz.</u> per Poldina L desk tavolo, Poldina L terra-tavolo) Single replacement battery pack (x1 <u>pc.</u> needed for Home Solar ; x2 <u>pcs.</u> needed for Pina, Push-up, Home ; x3 <u>pcs.</u> needed for Poldina L desk table lamp, Poldina L floor-table lamp)	3,7V 2200mA/H	BAT04703706701900 Pacco batteria sostitutiva doppia (necessario <u>1 pz.</u> per Poldina tavolo, Poldina mini tavolo, Poldina picchetto, Poldina sospensione, Poldina parete, Poldina Reverso, Poldina Stopper, Circe, Amelie, Olivia tavolo, Olivia mini tavolo, Ofelia tavolo, Dama, Olimpia ; necessari <u>3 pz.</u> per Poldina XXL terra-tavolo) Double replacement battery pack (1 <u>pc.</u> needed for Poldina table lamp, Poldina mini table lamp, Poldina lamp with peg, Poldina suspension lamp, Poldina wall lamp, Poldina Reverso, Poldina Stopper, Circe, Amelie, Olivia table lamp, Olivia mini table lamp, Ofelia table lamp, Dama, Olimpia ; 3 <u>pcs.</u> needed for Poldina XXL floor-table lamp)	3,7V 4400mA/H
BAT04701906701902 Pacco batteria sostitutiva singola (necessari <u>2 pz.</u> per Swap tavolo, Swap tavolo mini) Single replacement battery pack (2 <u>pcs.</u> needed for Swap table lamp, Swap mini table lamp)	3,7V 2600mA/H	BAT04703706701901 Pacco batteria sostitutiva doppia (necessari <u>2 pz.</u> per Super O) Double replacement battery pack (2 <u>pcs.</u> needed for Super O)	3,7V 5000mA/H
BAT04702719700300 Pacco batteria sostitutiva per modulo Pencil piccolo Replacement battery pack for small Pencil module	11,1V 5000mA/H	BAT04704004001000 Pacco batteria sostitutiva singola (necessario <u>1 pz.</u> per Poldina micro tavolo) Single replacement battery pack (1 <u>pc.</u> needed for Poldina micro table lamp)	3,7V 1900mA/H
BAT04702739200600 Pacco batteria sostitutiva per modulo Pencil medio Replacement battery pack for medium Pencil module	11,1V 10000mA/H	BAT04705506701900 Pacco batteria sostitutiva tripla (necessario <u>1 pz.</u> per Sister Light Wi-Fi) Triple replacement battery pack (x1 <u>pc.</u> needed for Sister Light Wi-Fi)	3,7V 7500mA/H
BAT04702758700900 Pacco batteria sostitutiva per modulo Pencil grande Replacement battery pack for large Pencil module	11,1V 15000mA/H	BAT04709003005000 Pacco batteria sostitutiva doppia (necessari <u>1 pz.</u> per Olivia micro tavolo, Ofelia micro tavolo) Double replacement battery pack (1 <u>pc.</u> needed for Olivia micro table lamp, Ofelia micro table lamp)	3,7V 3000mA/H



Video tutorial:
sostituzione batterie
Tutorial video:
battery replacement

Personalizzazione

Customization

Aggiungi un ulteriore tocco di personalità alle tue lampade: le portatili Zafferano possono essere decorate per assecondare le tue necessità o il tuo gusto. A seconda del modello, possiamo stampare un logo, una texture o un'immagine, sulla base o sul diffusore. Una nuovissima opzione consiste nella stampa delle cover in metallo per i diffusori di Poldina, con una tecnologia innovativa che permette di stampare su tutta la superficie della cover e garantisce un'eccezionale qualità e definizione del decoro.

Give your cordless lamps an extra touch of personality: Zafferano can decorate them, according to your needs or taste. Depending on the model, we can print a logo, texture or image on the base or diffuser. A brand new option is the printing of metal covers for Poldina lamp head, with an innovative technology that allows printing on the entire surface of the cover, guaranteeing exceptional quality and definition of the decoration.

Punti personalizzabili

Customizable spots

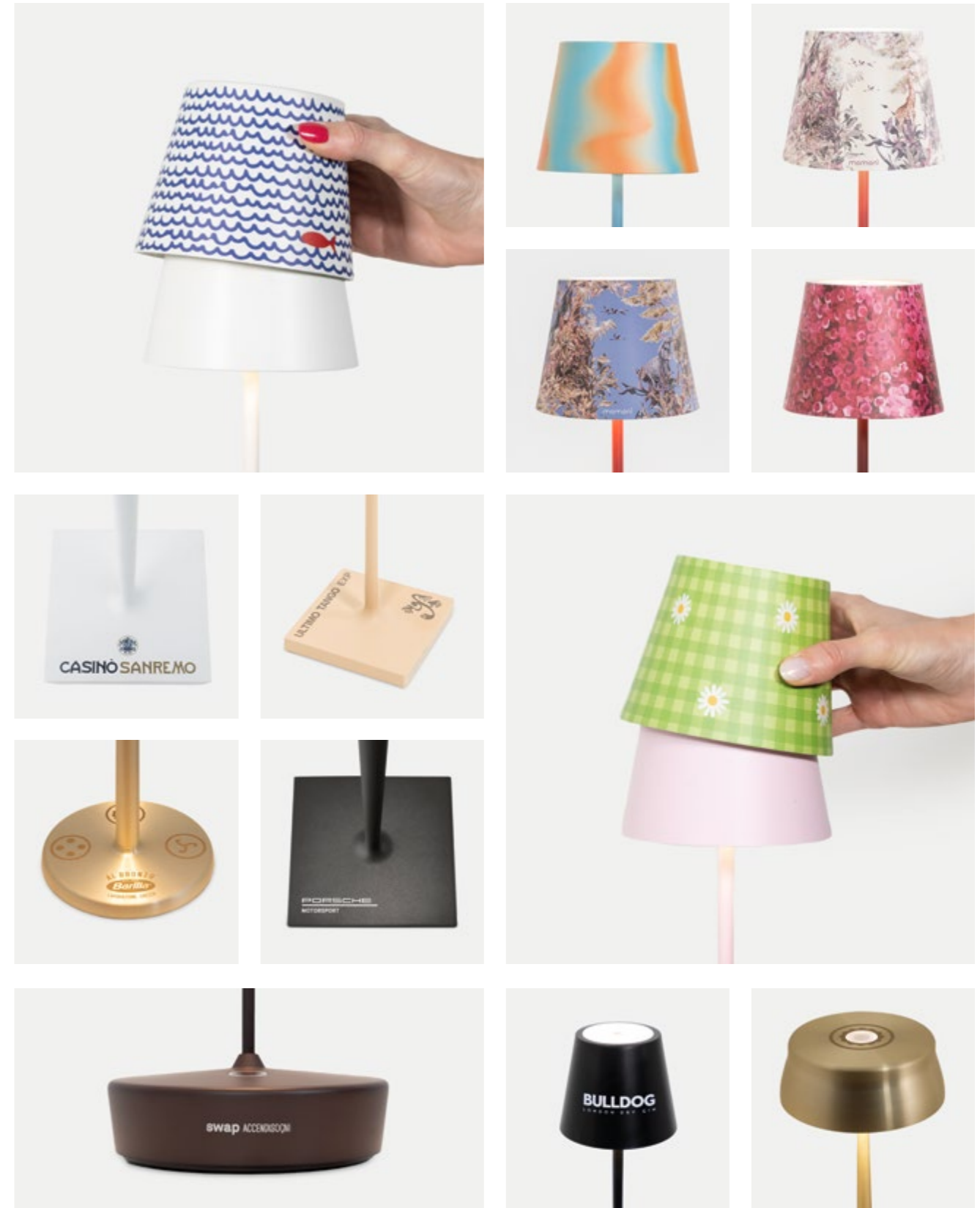
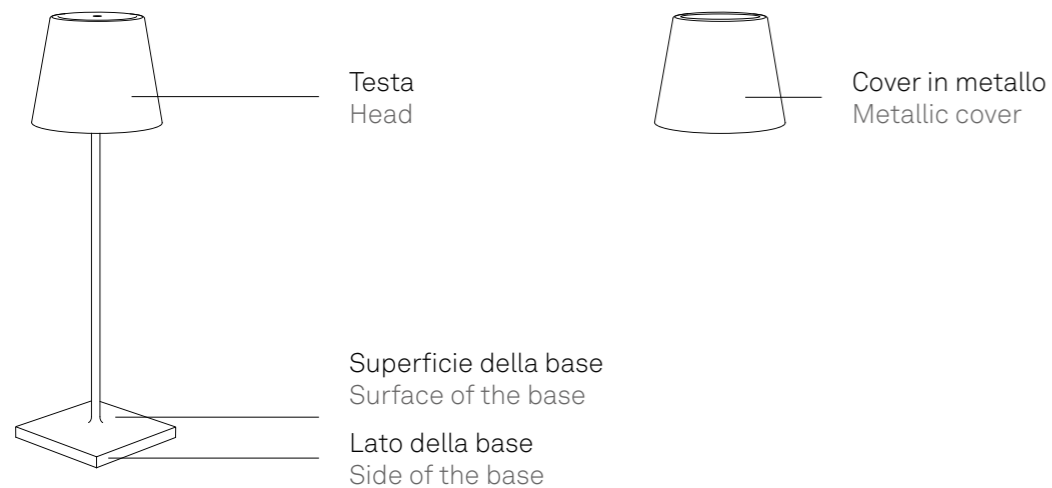



CE
Dichiara che il prodotto soddisfa gli standard dell'UE per la salute, la sicurezza e la protezione ambientale.
Declares that the product meets EU standards for health, safety, and environmental protection.



CLASS II
Apparecchio dotato di doppio isolamento e/o isolamento rinforzato in ogni parte e senza dispositivo di messa a terra.
Light fitting equipped with double isolation and/or isolation reinforced in every part and without earthing device.



CLASS III
Apparecchio basato su un'alimentazione a bassissima tensione di sicurezza, in cui non si producono tensioni superiori alla stessa.
Light fitting based on a very low safety voltage power supply, in which no tensions higher than the same are produced.



IP PROTECTION DEGREE
IP20: apparecchio protetto dalla penetrazione di corpi solidi di dimensioni maggiori a 12mm e non protetto dai liquidi.
IP54: apparecchio protetto da polveri e da spruzzi d'acqua.
IP65: apparecchio fortemente protetto da polveri e da getti d'acqua.
IP20: protected from the penetration of solid objects greater than 12 mm and non protected from liquids.
IP54: protected from dust and splashing water.
IP65: highly protected from dust and water jets.



DIMMABLE
Indica che è possibile regolare l'intensità luminosa della lampada.
Indicates that the light intensity of the lamp can be adjusted.

Zafferano.dk
CVR 30250257
Svalegabet 10
2850 Nærum
Telefon +45 60 57 74 01
info@zafferano.dk

Art Direction, Graphic Design
Zafferano Design
Photography
Zaff Design
Digital Snack
Alberto Sinigaglia
Quasar
Lago Design, Villa del Conte
Padua, Italy
Printing
L'ArteGrafica
June 2024

© Copyright Zafferano SRL
©2024 Peanuts Worldwide LLC
www.peanuts.com

CATLAP24-06

L'azienda si riserva di apportare modifiche e/o migliorie di carattere tecnico ed estetico ai propri modelli e prodotti in qualsiasi momento e senza preavviso.
The company reserves the right to make modifications and improvements of a technical or aesthetic nature to the products at any time without notice.

Il prodotto è protetto da garanzia, a norma di legge.
The product is covered by a warranty, according to the law.



